

DRAFT

USER'S GUIDE

BOXLIGHT XP-8t

 **BOXLIGHT**[®]
Presenting a Better Way

TO THE OWNER

Before operating this projector, read this manual thoroughly and operate the projector properly. This projector provides many convenient features and functions. Operating the projector properly enables you to manage those features and maintains it in better condition for a considerable time. Improper operation may result in not only shortening the product-life, but also malfunctions, fire hazard, or other accidents. If your projector seems to operate improperly, read this manual again, check operations and cable connections and try the solutions in the "Trouble-shooting" section of the end of this booklet. If the problem still persists, contact the sales dealer where you purchased the projector or the service center.



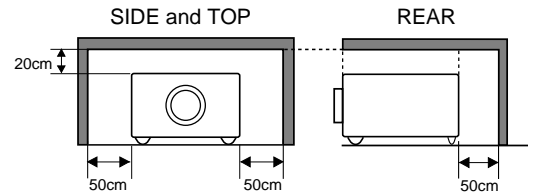

SAFETY PRECAUTIONS

WARNING : TO REDUCE THE RISK OF FIRE OR ELECTRIC SHOCK, DO NOT EXPOSE THIS APPLIANCE TO RAIN OR MOISTURE.

- This projector produces intense light from the projection lens. Do not stare directly into the lens as possible. Eye damage could result. Be especially careful that children do not stare directly into the beam.
- This projector should be set in the way indicated. If not, it may result in a fire hazard.
- Take appropriate space on the top, sides and rear of the projector cabinet for allowing air circulation and cooling the projector. Minimum distance should be taken. If the projector is to be built into a compartment or similarly enclosed, the minimum distances must be maintained. Do not cover the ventilation slot on the projector. Heat build-up can reduce the service life of your projector, and can also be dangerous.
- Do not put any flammable object or spray can near the projector, hot air is exhausted from the ventilation holes.
- If the projector is not to be used for an extended time, unplug the projector from the power outlet.



READ AND KEEP THIS OWNER'S MANUAL FOR LATER USE.

	CAUTION RISK OF ELECTRIC SHOCK DO NOT OPEN	
CAUTION : TO REDUCE THE RISK OF ELECTRIC SHOCK, DO NOT REMOVE COVER (OR BACK). NO USER-SERVICEABLE PARTS INSIDE EXCEPT LAMP REPLACEMENT. REFER SERVICING TO QUALIFIED SERVICE PERSONNEL.		
 THIS SYMBOL INDICATES THAT DANGEROUS VOLTAGE CONSTITUTING A RISK OF ELECTRIC SHOCK IS PRESENT WITHIN THIS UNIT.	 THIS SYMBOL INDICATES THAT THERE ARE IMPORTANT OPERATING AND MAINTENANCE INSTRUCTIONS IN THE OWNER'S MANUAL WITH THIS UNIT.	

SAFETY INSTRUCTIONS

All the safety and operating instructions should be read before the product is operated.

Read all of the instructions given here and retain them for later use. Unplug this projector from AC power supply before cleaning. Do not use liquid or aerosol cleaners. Use a damp cloth for cleaning.

Follow all warnings and instructions marked on the projector.

For added protection to the projector during a lightning storm, or when it is left unattended and unused for long periods of time, unplug it from the wall outlet. This will prevent damage due to lightning and power line surges.

Do not expose this unit to rain or use near water... for example, in a wet basement, near a swimming pool, etc...

Do not use attachments not recommended by the manufacturer as they may cause hazards.

Do not place this projector on an unstable cart, stand, or table. The projector may fall, causing serious injury to a child or adult, and serious damage to the projector. Use only with a cart or stand recommended by the manufacturer, or sold with the projector. Wall or shelf mounting should follow the manufacturer's instructions, and should use a mounting kit approved by the manufacturers.

An appliance and cart combination should be moved with care. Quick stops, excessive force, and uneven surfaces may cause the appliance and cart combination to overturn.



Slots and openings in the back and bottom of the cabinet are provided for ventilation, to insure reliable operation of the equipment and to protect it from overheating.

The openings should never be covered with cloth or other materials, and the bottom opening should not be blocked by placing the projector on a bed, sofa, rug, or other similar surface. This projector should never be placed near or over a radiator or heat register.

This projector should not be placed in a built-in installation such as a book case unless proper ventilation is provided.

Never push objects of any kind into this projector through cabinet slots as they may touch dangerous voltage points or short out parts that could result in a fire or electric shock. Never spill liquid of any kind on the projector.

This projector should be operated only from the type of power source indicated on the marking label. If you are not sure of the type of power supplied, consult your authorized dealer or local power company.

Do not overload wall outlets and extension cords as this can result in fire or electric shock. Do not allow anything to rest on the power cord. Do not locate this projector where the cord may be damaged by persons walking on it.

Do not attempt to service this projector yourself as opening or removing covers may expose you to dangerous voltage or other hazards. Refer all servicing to qualified service personnel.

Unplug this projector from wall outlet and refer servicing to qualified service personnel under the following conditions:

- a. When the power cord or plug is damaged or frayed.
- b. If liquid has been spilled into the projector.
- c. If the projector has been exposed to rain or water.
- d. If the projector does not operate normally by following the operating instructions. Adjust only those controls that are covered by the operating instructions as improper adjustment of other controls may result in damage and will often require extensive work by a qualified technician to restore the projector to normal operation.
- e. If the projector has been dropped or the cabinet has been damaged.
- f. When the projector exhibits a distinct change in performance-this indicates a need for service.

When replacement parts are required, be sure the service technician has used replacement parts specified by the manufacturer that have the same characteristics as the original part. Unauthorized substitutions may result in fire, electric shock, or injury to persons.

Upon completion of any service or repairs to this projector, ask the service technician to perform routine safety checks to determine that the projector is in safe operating condition.

Voor de klanten in Nederland



Bij dit product zijn batterijen geleverd. Wanneer deze leeg zijn, moet u ze niet weggooien maar inleveren als KCA.

COMPLIANCES

Federal Communication Commission Notice

Note : This equipment has been tested and found to comply with the limits for a Class B digital device, pursuant to part 15 of the FCC Rules. These limits are designed to provide reasonable protection against harmful interference in a residential installation. This equipment generates, uses and can radiate radio frequency energy and, if not installed and used in accordance with the instructions, may cause harmful interference to radio communications. However, there is no guarantee that interference will not occur in a particular installation. If this equipment does cause harmful interference to radio or television reception, which can be determined by turning the equipment off and on, the user is encouraged to try to correct the interference by one or more of the following measures :

- Reorient or relocate the receiving antenna.
- Increase the separation between the equipment and receiver.
- Connect the equipment into an outlet on a circuit different from that to which the receiver is connected.
- Consult the dealer or an experienced radio/TV technician for help.

Use of shielded cable is required to comply with class B limits in Subpart B of Part 15 of FCC Rules.

Do not make any changes or modifications to the equipment unless otherwise specified in the instructions. If such changes or modifications should be made, you could be required to stop operation of the equipment.

Model Number : BOXLIGHT XP-8t
Trade Name : Boxlight
Responsible party : BOXLIGHT
Address : 19332 Powder Hill Place Poulsbo, WA 98370-7407 USA
Telephone No. : (800)762-5757

AC POWER CORD REQUIREMENT

The AC Power Cord supplied with this projector meets the requirement for use in the country you purchased it.

AC Power Cord for the United States and Canada :

AC Power Cord used in the United States and Canada is listed by the Underwriters Laboratories (UL) and certified by the Canadian Standard Association (CSA).

AC Power Cord has a grounding-type AC line plug. This is a safety feature to be sure that the plug will fit into the power outlet. Do not try to defeat this safety feature. Should you be unable to insert the plug into the outlet, contact your electrician.

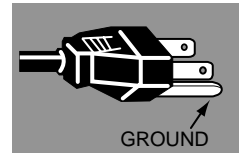

THE SOCKET-OUTLET SHOULD BE INSTALLED NEAR THE EQUIPMENT AND EASILY ACCESSIBLE.

TABLE OF CONTENTS

FEATURES AND DESIGN	6	COMPUTER INPUT	22
PREPARATION	7	SELECTING INPUT SOURCE	22
NAME OF EACH PART OF PROJECTOR	7	SELECTING COMPUTER SYSTEM	22
SETTING-UP PROJECTOR	8	COMPATIBLE COMPUTER SPECIFICATIONS	23
CONNECTING AC POWER CORD	8	PC ADJUSTMENT	24
POSITIONING PROJECTOR	9	AUTO PC ADJUSTMENT	24
ADJUSTABLE FEET	9	MANUAL PC ADJUSTMENT	25
MOVING PROJECTOR	10	PICTURE IMAGE ADJUSTMENT	27
		IMAGE LEVEL SELECT	27
		IMAGE LEVEL ADJUSTMENT	28
		PICTURE SCREEN ADJUSTMENT	29
CONNECTING PROJECTOR	11	VIDEO INPUT	30
TERMINALS OF PROJECTOR	11	SELECTING INPUT SOURCE	30
CONNECTING TO COMPUTER	12	SELECTING VIDEO SYSTEM	31
CONNECTING TO VIDEO EQUIPMENT	13	PICTURE IMAGE ADJUSTMENT	32
		IMAGE LEVEL SELECT	32
		IMAGE LEVEL ADJUSTMENT	33
		PICTURE SCREEN ADJUSTMENT	34
BEFORE OPERATION	14	SETTING	35
OPERATION OF REMOTE CONTROL	14	SETTING MENU	35
OPERATING RANGE	15		
REMOTE CONTROL BATTERY INSTALLATION	15		
TOP CONTROLS AND INDICATORS	16		
OPERATING ON-SCREEN MENU	17		
HOW TO OPERATE ON-SCREEN MENU	17		
FLOW OF ON-SCREEN MENU OPERATION	17		
MENU BAR	18		
BASIC OPERATION	19	APPENDIX	37
TURNING ON / OFF PROJECTOR	19	MAINTENANCE	37
ADJUSTING SCREEN	20	WARNING TEMP. INDICATOR	37
ZOOM ADJUSTMENT	20	AIR FILTER CARE AND CLEANING	37
FOCUS ADJUSTMENT	20	CLEANING PROJECTION LENS	37
KEystone ADJUSTMENT	20	LAMP REPLACEMENT	38
PICTURE FREEZE FUNCTION	20	LAMP REPLACE COUNTER	38
NO SHOW FUNCTION	21	TROUBLESHOOTING	39
P-TIMER FUNCTION	21	TECHNICAL SPECIFICATIONS	41
SOUND ADJUSTMENT	21		

TRADEMARKS

- Apple, Macintosh, and PowerBook are trademarks or registered trademarks of Apple Computer, Inc.
- IBM and PS/2 are trademarks or registered trademarks of International Business Machines, Inc.
- Windows and PowerPoint are registered trademarks of Microsoft Corporation.
- Each name of corporations or products in the owner's manual is a trademark or a registered trademark of its respective corporation.

FEATURES AND DESIGN

This Multimedia Projector is designed with the most advanced technology for portability, durability, and ease of use. This projector utilizes built-in multimedia features, a palette of 16.77 million colors, and matrix liquid crystal display (LCD) technology.

◆ Compact Design

This projector is extremely compact in size and weight. It is designed to carry and work anywhere you wish to use.

◆ Compatibility

This projector widely accepts various video and computer input signals including;

- **Computers**
IBM-compatible or Macintosh computer up to 1280 x 1024 resolution.
- **6 Color Systems**
NTSC, PAL, SECAM, NTSC 4.43, PAL-M or PAL-N color system can be connected.
- **Component Video**
Component video signal, such as a DVD player output, high definition TV signals including 480i, 480p, 575i, 575p, 720p, 1035i or 1080i, can be connected.
- **S-Video**
S-Video signal, such as a S-VHS VCR output signal, can be connected.

◆ High Resolution Image

This projector provides 1024 x 768 dots resolution for computer input and 550 horizontal TV lines. Resolution from a computer between XGA (1024 x 768) and SXGA (1280 x 1024) is compressed into 1024 x 768 dots. This projector cannot display image of over 1280 x 1024 dots. When resolution of your computer is higher than 1280 x 1024, reset a computer output for lower resolution.

◆ Multi-Scan System

This projector has Multi-Scan System to conform to almost all computer output signals quickly. There is no need for troublesome manual adjustment of frequency and other settings.

◆ One-Touch Auto PC Adjustment

Incoming computer video signals are recognized and the best adjustment is automatically set by Auto PC Adjustment. No complicated setup is necessary and projection is always precise.

◆ Digital Zoom (for Computer)

Digital Zoom function expands (to approx. 16 times of screen size) or compress the image size, allowing you to focus on crucial information at a presentation.

◆ Keystone Correction

Positioning height of a projector may result in distorted image being displayed in a trapezoid shape. Keystone Correction solves this problem by digitally altering projection to produce undistorted images.

◆ Power Management

Power Management function is provided to reduce power consumption while a projector is not in use. This Power Management function operates to turn Projection Lamp off when a projector detects signal interruption and any button is not pressed over 5 minutes. Projection Lamp is automatically turned on again when a projector detects signal or any operation button is pressed. This projector is shipped with this function ON.

◆ Multilanguage Menu Display

Operation menu is displayed in; English, German, French, Italian, Spanish, Portuguese, Dutch, Swedish, Chinese, Korean or Japanese.

PREPARATION

NAME OF EACH PART OF PROJECTOR

FRONT

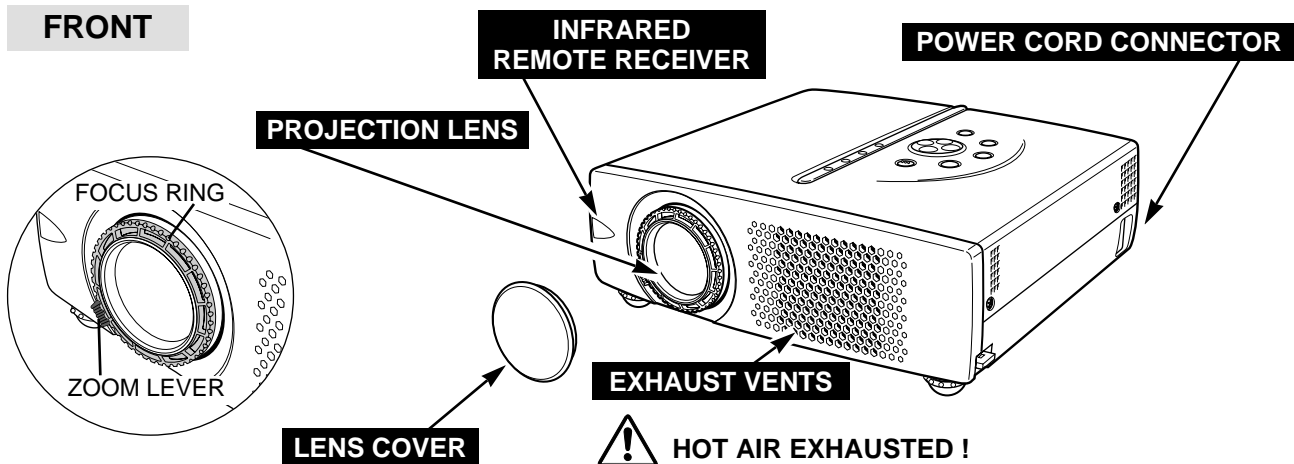

! HOT AIR EXHAUSTED !

Air blown from Exhaust Vents is hot. When using or installing projector, following precautions should be taken.

- Do not put any flammable object near these vents.
- Keep front grills at least 3'(1m) away from any object, especially heat-sensitive object.
- Do not touch this area, especially screw and metallic part. This area will become hot while a projector is used.

This projector detects internal temperature and automatically controls operating power of Cooling Fans.

BACK

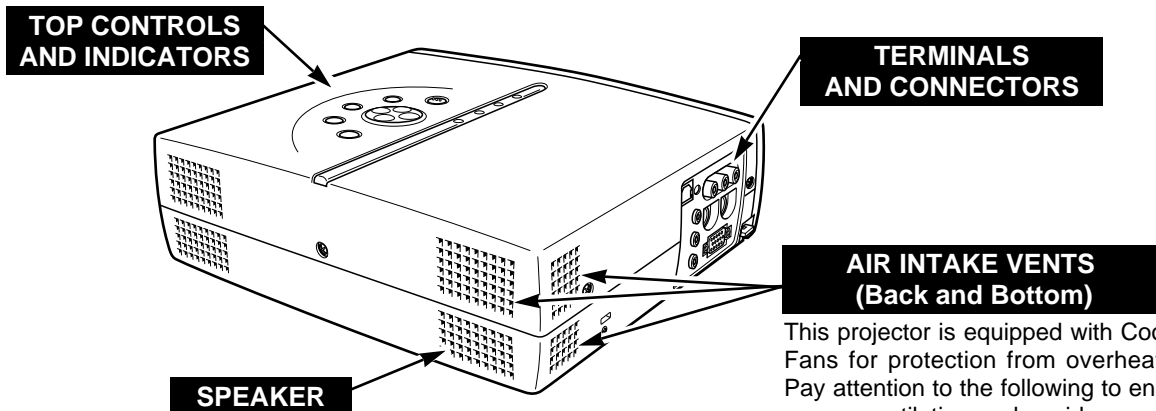

This projector is equipped with Cooling Fans for protection from overheating. Pay attention to the following to ensure proper ventilation and avoid a possible risk of fire and malfunction.

- Do not cover vent slots.
- Keep back and bottom clear of any object. Obstructions may block cooling air.

BOTTOM

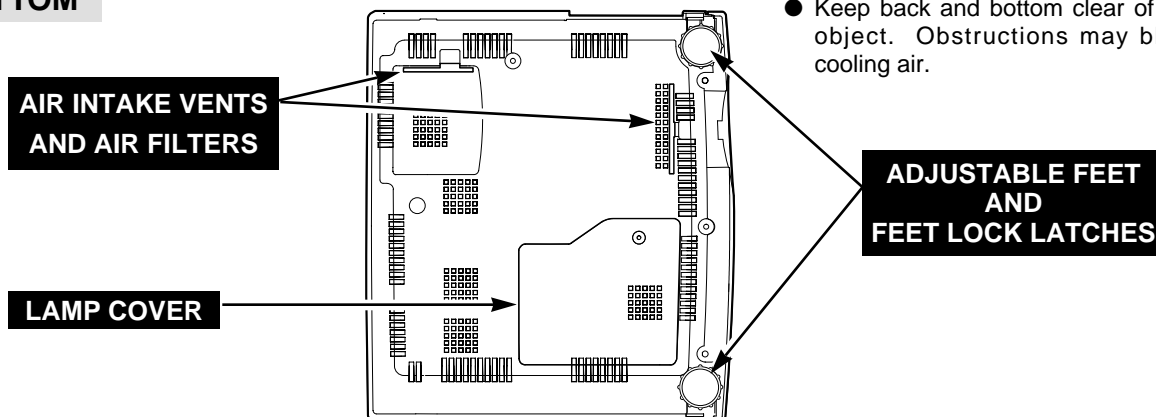

SETTING-UP PROJECTOR

CONNECTING AC POWER CORD

This projector uses nominal input voltages of 100-120 V or 200-240 V AC. This projector automatically selects the correct input voltage. It is designed to work with single-phase power systems having a grounded neutral conductor. To reduce risk of electrical shock, do not plug into any other type of power system. Consult your authorized dealer or service station if you are not sure of the type of power supply being in use. Connect a projector with a peripheral equipment before turning a projector on. (Refer to pages 11 ~ 13 for connection.)

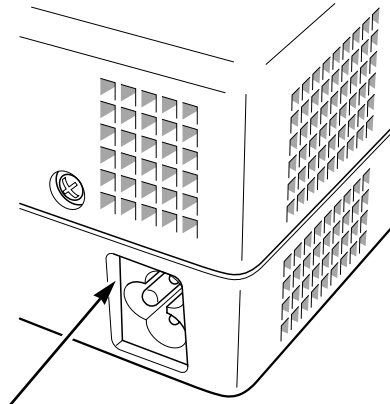

Connect AC Power Cord (supplied) to a projector. The AC outlet must be near this equipment and must be easily accessible.



CAUTION

For safety, unplug AC Power Cord when an appliance is not used. When this projector is connected to the outlet with AC Power Cord, an appliance is in Stand-by Mode and consumes a little electric power.

NOTE ON THE POWER CORD

AC Power Cord must meet requirement of the country where you use a projector. Confirm an AC plug type with the chart below and proper AC Power Cord must be used. If supplied AC Power Cord does not match your AC outlet, contact your sales dealer.

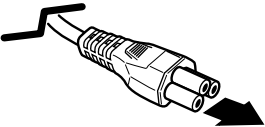
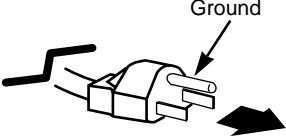
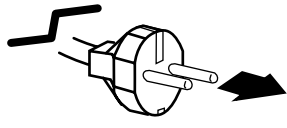
Projector side	AC Outlet side	
 <p data-bbox="373 1375 592 1449">To POWER CORD CONNECTOR on your projector.</p>	<p data-bbox="625 1165 933 1207">For the U.S.A. and Canada</p>  <p data-bbox="755 1375 925 1438">To the AC Outlet. (120 V AC)</p>	<p data-bbox="958 1165 1258 1207">For Continental Europe</p>  <p data-bbox="1079 1396 1258 1459">To the AC Outlet. (200 - 240 V AC)</p>

POSITIONING PROJECTOR

- This projector is designed to project on a flat projection surface.
- The projector can be focused from 5.3'(1.6m) ~ 26.6'(8.1m).
- Refer to the figure below to adjust a screen size.

ROOM LIGHT

The brightness in a room has a great influence on picture quality. It is recommended to limit ambient lighting in order to provide the best image.

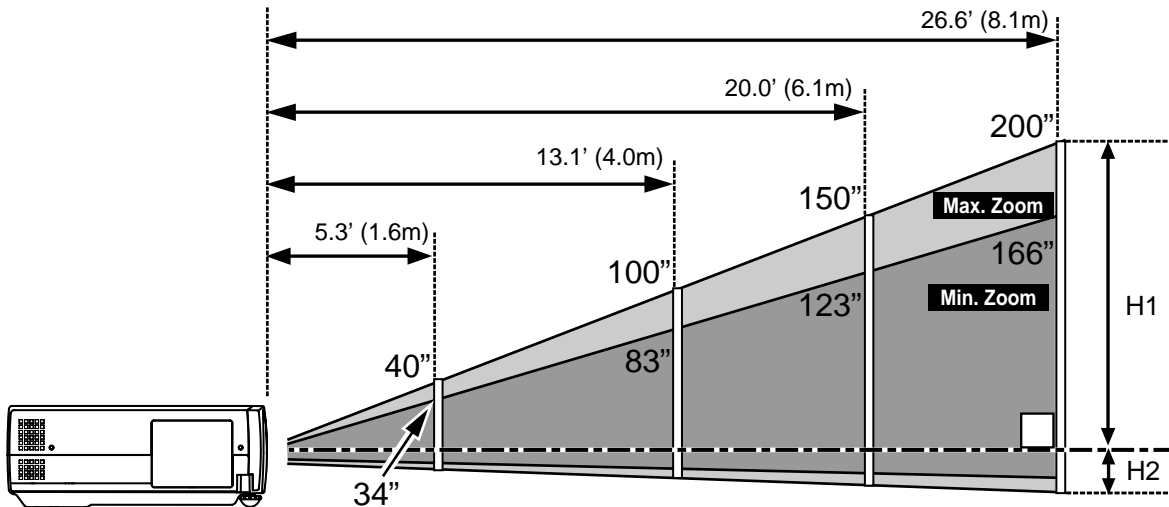

Screen Size (W x H) mm	34"	40"	100"	150"	200"
Screen Size (W x H) mm	690.9 x 518.2	812.8 x 609.6	2032 x 1524	3048 x 2286	4064 x 3048
Height (H1)	19.4"(492.3mm)	22.8"(579.12mm)	57"(1447.8mm)	85.5"(2171.7mm)	114"(2895.6mm)
Height (H2)	1.0"(25.9mm)	1.2"(30.48mm)	3"(76.2mm)	4.5"(114.3mm)	6"(152.4mm)

ADJUSTABLE FEET

Picture tilt and projection angle can be adjusted by rotating ADJUSTABLE FEET. Projection angle can be adjusted to 10.6 degrees.

- 1 Lift the front of a projector and pull FEET LOCK LATCHES on the both sides of a projector.
- 2 Release FEET LOCK LATCHES to lock ADJUSTABLE FEET and rotate ADJUSTABLE FEET to adjust position and tilt.
- 3 To retract ADJUSTABLE FEET, lift the front of a projector and pull and undo FEET LOCK LATCHES.
Keystone distortion of a projected image can be adjusted by Menu Operation. (Refer to P20 and 35.)

CAUTION

Avoid positioning a projector with the angle of more than 20 degrees. Projection Lamp may malfunction.

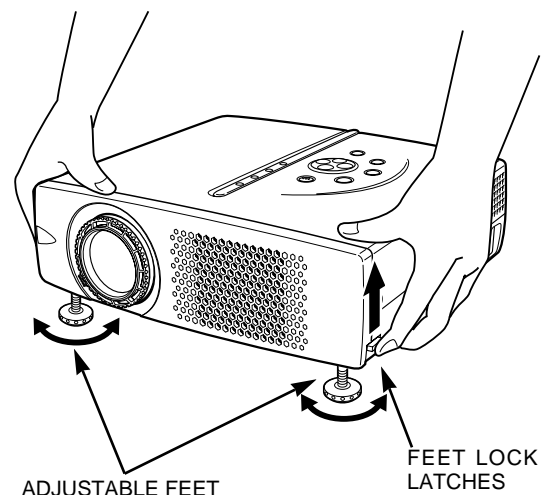

MOVING PROJECTOR

When moving a projector, replace Lens Cover and retract Adjustable Feet to prevent damage to the lens and cabinet. When the projector is not in use for an extended period, put it into the case (carrying bag) supplied with the projector.



CAUTION

Carrying Bag (supplied) is intended for protection from dust and scratches on the surface of a cabinet, and it is not designed to protect an appliance from external forces. Do not transport a projector through a courier or transport services with this bag, otherwise the projector can be damaged. When handling a projector, do not drop, bump, subject it to strong forces or put other things on the cabinet.



CAUTION IN CARRYING OR TRANSPORTING THE PROJECTOR

- Do not drop or bump a projector, otherwise damages or malfunctions may result.
- When carrying a projector, use a suitable carrying case.
- Do not transport a projector by using a courier or transport service in an unsuitable transport case. This may cause damage to a projector. To transport a projector through a courier or transport service, consult Boxlight dealer for best way.

CONNECTING PROJECTOR

TERMINALS OF PROJECTOR

This projector has input and output terminals on its side for connecting computers and video equipment. Refer to figures on pages 11 to 13 and connect properly.

USB CONNECTOR (Series B)

When controlling the computer with Remote Control Unit of this projector, connect USB port of your personal computer to this connector. (Refer to P12.)

RESET BUTTON

This projector uses a micro processor to control this unit, and occasionally, this micro processor may malfunction and need to be reset. This can be done by pressing RESET button with a pen, which will shut down and restart the unit. Do not use RESET function excessively.

VIDEO INPUT JACKS

Connect the composite video output from video equipment to VIDEO/Y jack or connect the component video outputs to VIDEO/Y, Pb/Cb and Pr/Cr jacks. (Refer to P13.)

S-VIDEO INPUT JACK

Connect the S-VIDEO output from video equipment to this jack. (Refer to P13.)

CONTROL PORT CONNECTOR

When controlling the computer with Remote Control Unit of this projector, connect the mouse port of your personal computer to this connector. (Refer to P12.)

COMPUTER INPUT TERMINAL (ANALOG)

Connect the computer output to this jack. (Refer to P12.)

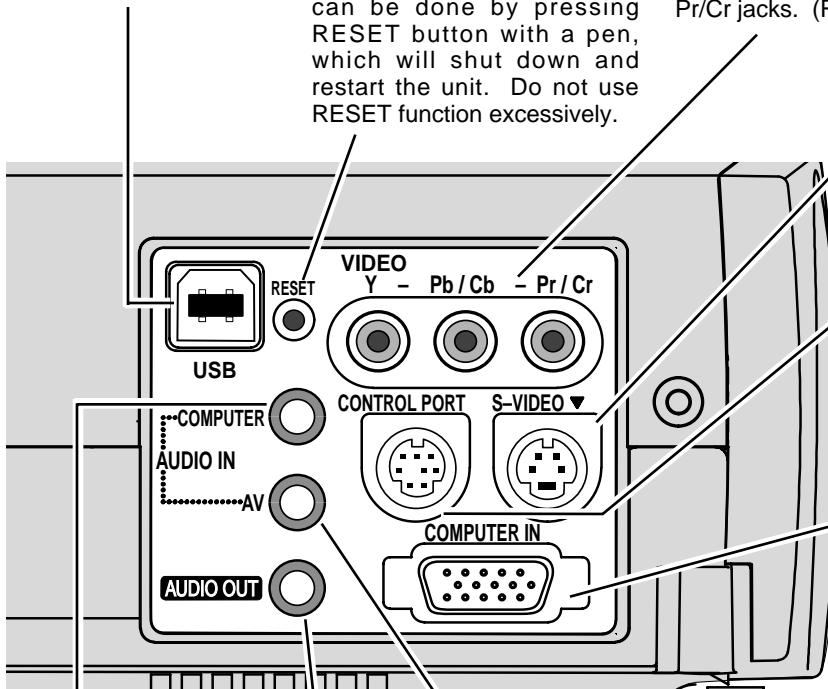

COMPUTER AUDIO INPUT JACK

Connect the audio output (stereo) from computer to this jack. (Refer to P12.)

AUDIO OUTPUT JACK

Connect an external audio amplifier to this jack. (Refer to P12, 13.)

AUDIO INPUT JACK

Connect the audio output from video equipment to this jack. (Refer to P13.)

CONNECTING TO COMPUTER

Cables used for connection (* = Cable or adapter is not supplied with this projector.)

- VGA Cable (HDB 15 pin)
- Control Cable for PS/2 Port *, Serial Port *, or ADB Port *
- USB Cable *
- MAC Adapter (When connecting to Macintosh computer) *
- Audio Cable (Mini Plug (stereo) x 1) *

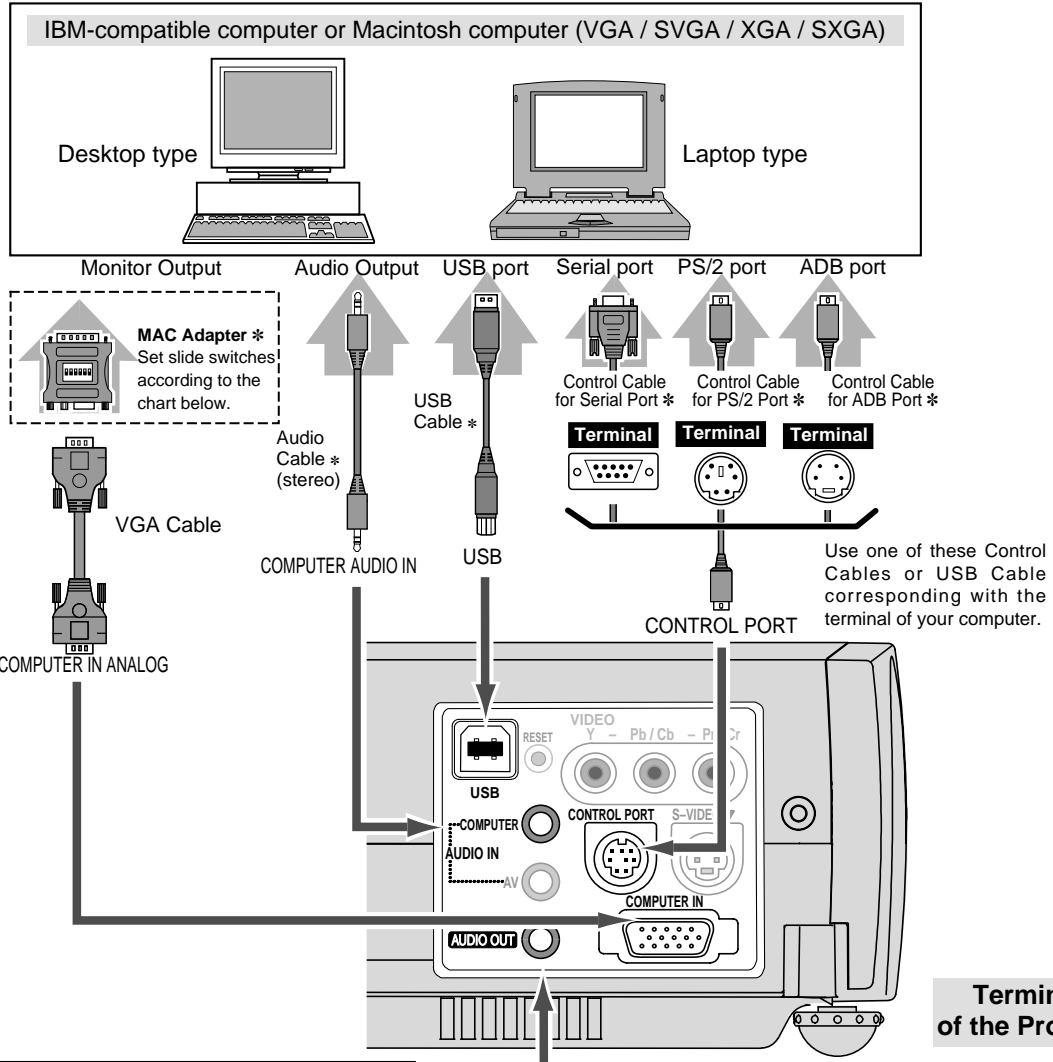

Terminals of the Projector



NOTE :
When connecting the cable, the power cords of both the projector and the external equipment should be disconnected from AC outlet. Turn the projector and peripheral equipment on before the computer is switched on.

◆ MAC ADAPTER (Not supplied)

Set switches as shown in the table below depending on RESOLUTION MODE that you want to use before you turn on projector and computer.

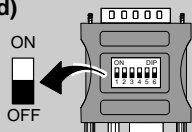

	1	2	3	4	5	6
13" MODE (640 x 480)	ON	ON	OFF	OFF	OFF	OFF
16" MODE (832 x 624)	OFF	ON	OFF	ON	OFF	OFF
19" MODE (1024 x 768)	OFF	ON	ON	OFF	OFF	OFF
21" MODE (1152 x 870)	ON	ON	ON	ON	OFF	OFF

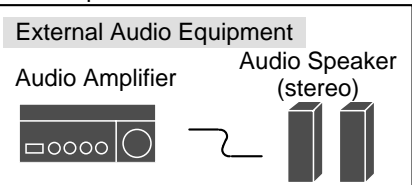
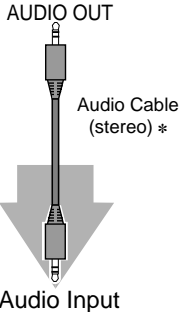

CONNECTING TO VIDEO EQUIPMENT

Cables used for connection (* = Cable is not supplied with this projector.)

- Video Cable (RCA x 1 or RCA x 3) *
- S-VIDEO Cable *
- Audio Cable (Mini Plug (stereo) x 1) *

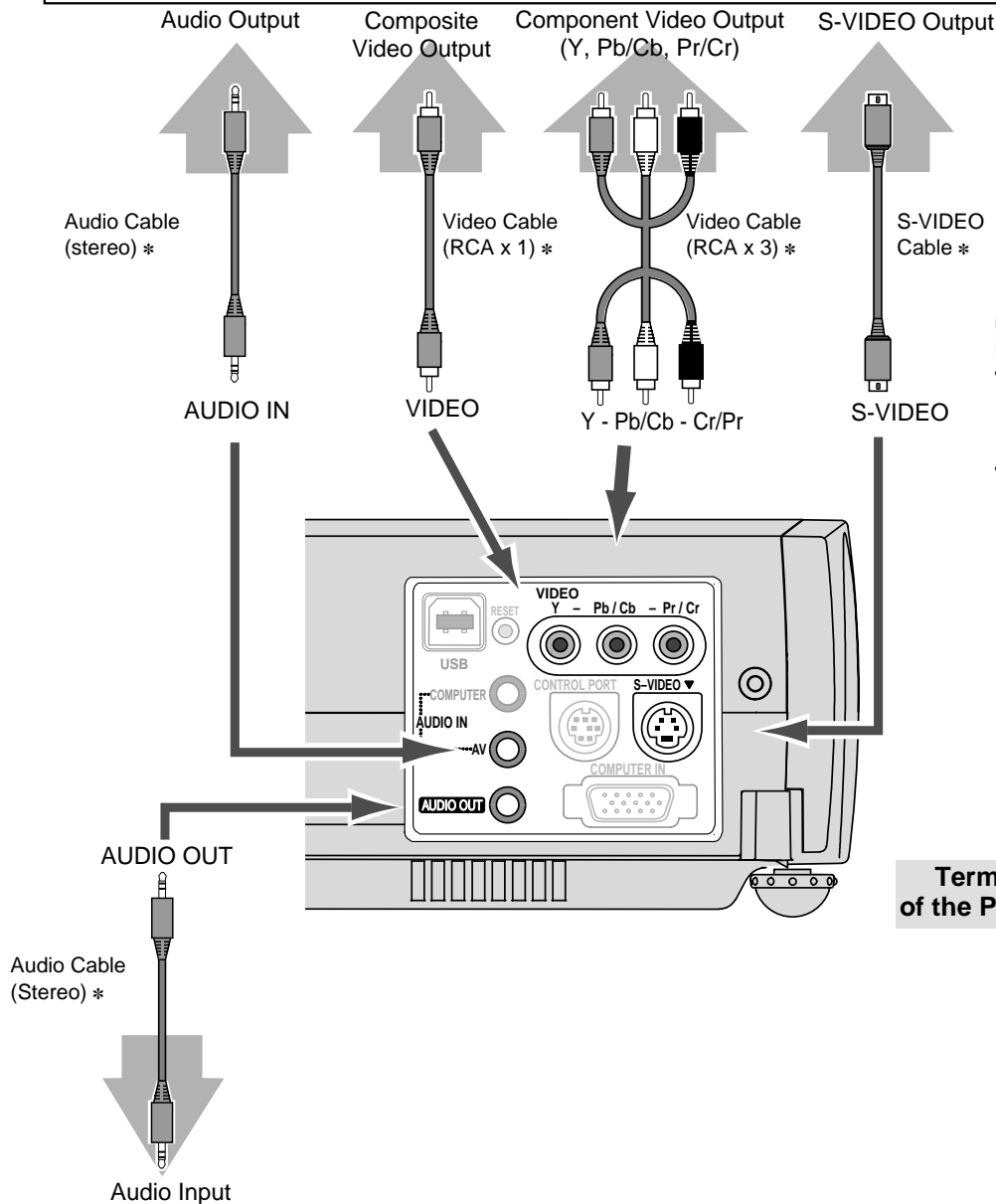
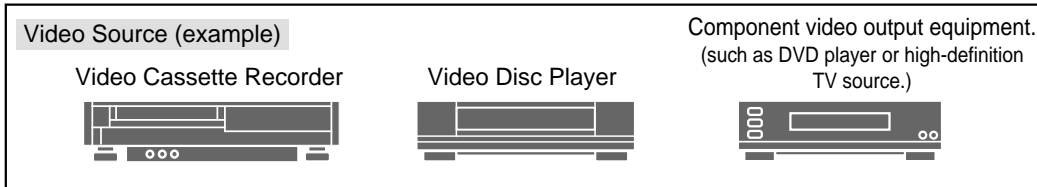

Use any of VIDEO jack Y-Pb/Cb-Pr/Cr jacks or S-VIDEO jack.

- When both VIDEO jack and S-VIDEO jack are connected, S-VIDEO jack has priority over VIDEO jack.
- When both Y-Pb/Cb-Pr/Cr jacks and S-VIDEO jack are connected, Y-Pb/Cb-Pr/Cr jacks has priority over S-VIDEO jack.

NOTE : When connecting the cable, the power cords of both the projector and the external equipment should be disconnected from AC outlet.

BEFORE OPERATION

OPERATION OF REMOTE CONTROL

Infrared signals are transmitted from this point.

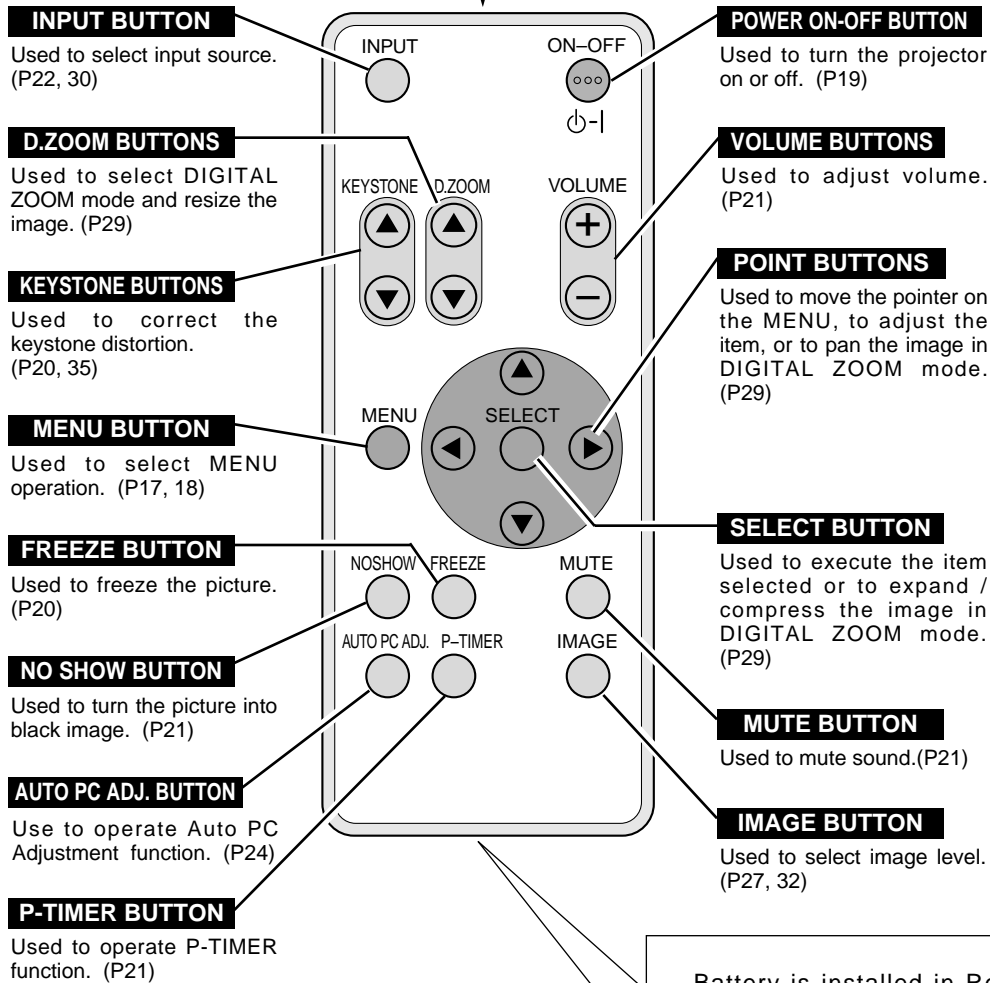

To insure safe operation, please observe the following precautions :

- Do not bend, drop Remote Control Unit, or expose Remote Control Unit to moisture or heat.
- For cleaning, use soft dry cloth. Do not apply benzene, thinner, splay or any chemical material.

Battery is installed in Remote Control Unit.

Before operation, pull out and remove a protect sheet from Remote Control Unit. This sheet protecting discharge of a battery.

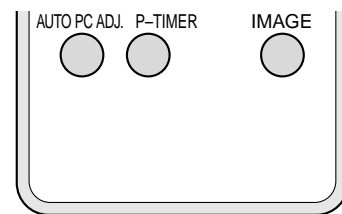

↓ Pull and remove.
BATTERY PROTECT SHEET
(transparent sheet)

OPERATING RANGE

Point Remote Control Unit toward projector (Receiver Window) whenever pressing any button. Maximum operating range for Remote Control Unit is about 16.4' (5m) and 60° in front of the projector.

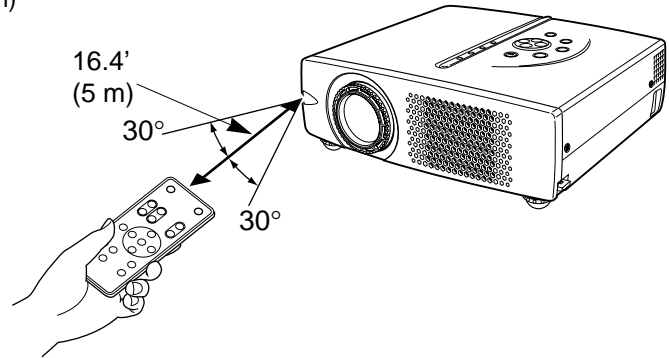

REMOTE CONTROL BATTERY INSTALLATION

1 Pull out Battery Holder.

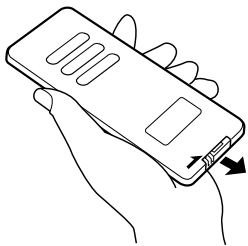

2 Replace with new battery. Install with battery (+),(-) marks properly.

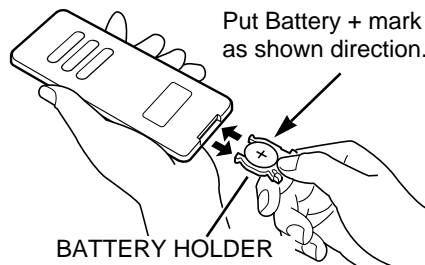

3 Install battery and Battery Holder into Remote Control Unit.

BATTERY	
LITHIUM BATTERY CR2025 (3.0V)	
	(+) mark indicates its (+) polarity.



To insure safe operation, please observe the following precautions :

- Use only specified battery. Improper battery may cause malfunction of Remote Control or improper battery's installation may cause explosion.
- Be sure to install battery with correct polarity.
- Do not expose a battery to moisture or heat. Do not charge a battery.
- If a battery have leaked on Remote Cotrol Unit, carefully wipe the case clean and load a new battery.
- Dispose used battery according to the battery-manufacturer's instrunctions.

TOP CONTROLS AND INDICATORS

This projector has CONTROL BUTTONS (TOP CONTROLS) and INDICATORS on its top.

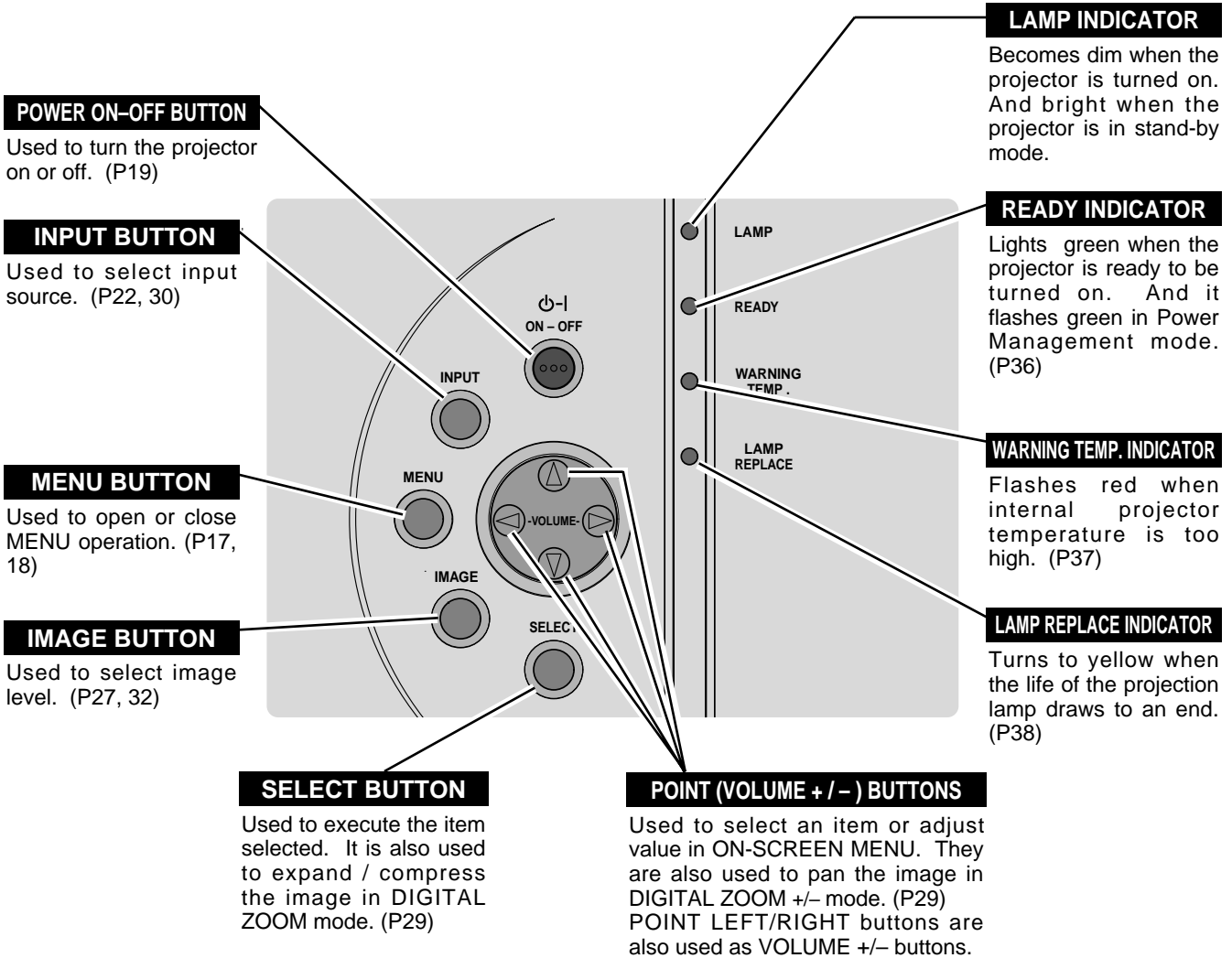

OPERATING ON-SCREEN MENU

HOW TO OPERATE ON-SCREEN MENU

You can control and adjust this projector through ON-SCREEN MENU. Refer to the following pages to operate each adjustment on ON-SCREEN MENU.

1 DISPLAY MENU

Press MENU button to display ON-SCREEN MENU.

2 MOVING POINTER

Move the pointer (* see below) or adjust the value of item by pressing POINT button(s) on Top Control or on Remote Control Unit.

* Pointer is the icon on ON-SCREEN MENU to select the item. See the figures on the section "FLOW OF ON-SCREEN MENU OPERATION" below.

3 SELECT ITEM

Select the item or set selected function by pressing SELECT button.

WIRELESS REMOTE CONTROL

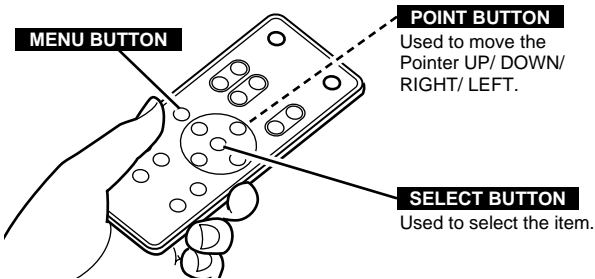

TOP CONTROL

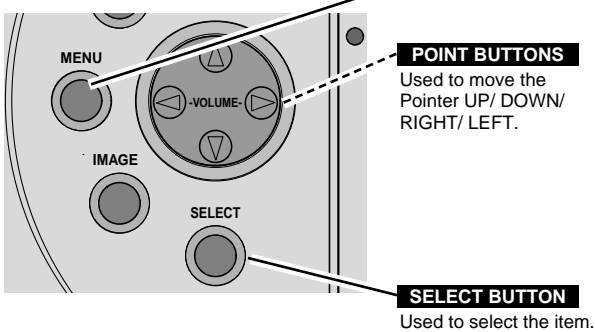

FLOW OF ON-SCREEN MENU OPERATION

Display ON-SCREEN MENU

1 Press MENU button to display ON-SCREEN MENU (MENU BAR). A red frame is POINTER.

Select Menu to be adjusted

2 Move POINTER (red frame) to MENU ICON that you want to select by pressing POINT RIGHT / LEFT buttons.

Control or adjust item through ON-SCREEN MENU

3 Press POINT DOWN button and move POINTER (red frame or red arrow) to ITEM that you want to adjust, and then press SELECT button to show ITEM DATA.

4 Adjust ITEM DATA by pressing POINT RIGHT / LEFT buttons. Refer to the following pages for details of respective adjustments.

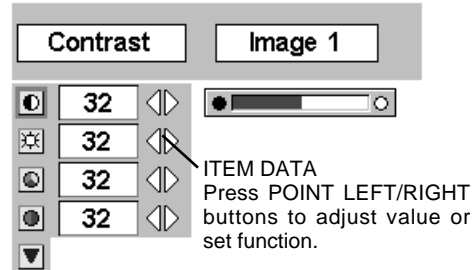
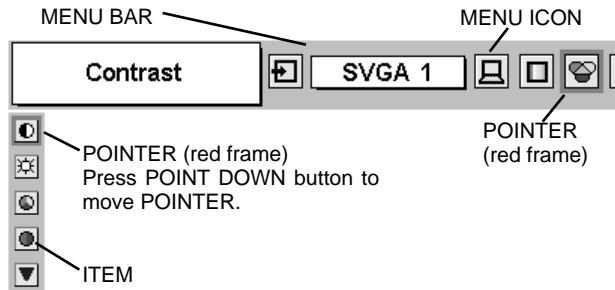

MENU BAR

FOR PC SOURCE

Press MENU BUTTON while connecting to PC input source.

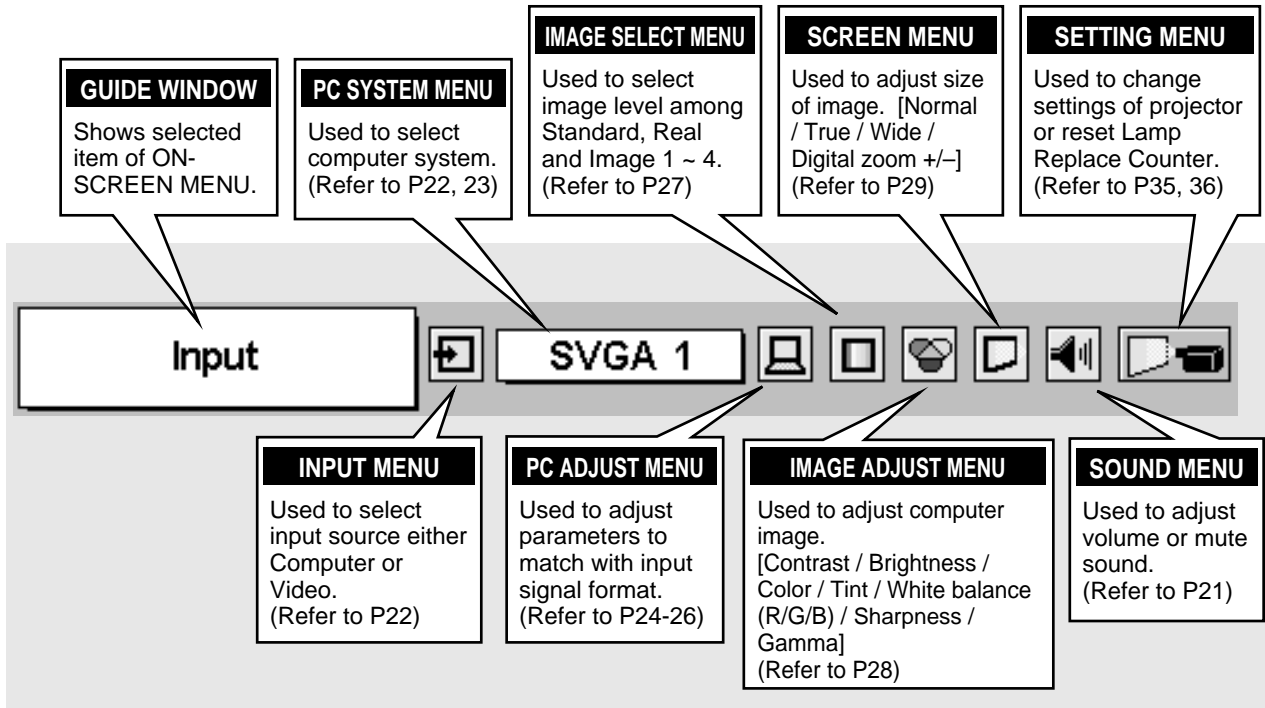

FOR VIDEO SOURCE

Press MENU BUTTON while connecting to VIDEO input source.

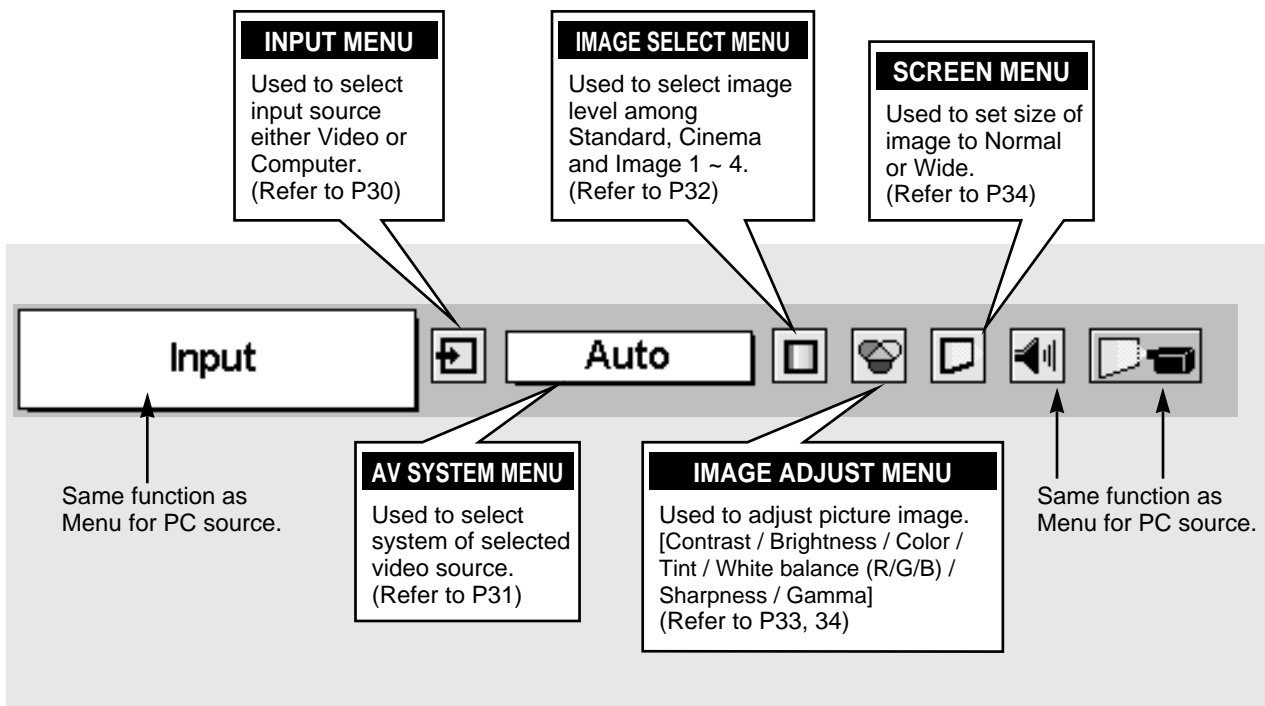

TURNING ON / OFF PROJECTOR

TURNING ON PROJECTOR

- 1** Complete peripheral connections (with Computer, VCR, etc.) before turning on projector. (Refer to "CONNECTING TO PROJECTOR" on pages 11~13 for connecting that equipment.)
- 2** Connect the projector's AC Power Cord into an AC outlet. LAMP Indicator lights RED, and READY Indicator lights GREEN.
- 3** Press POWER ON-OFF button on Top Control or on Remote Control Unit to ON. LAMP Indicator dims, and Cooling Fans start to operate. Preparation Display appears on a screen and the count-down starts. The signal from PC or Video source appears after 30 seconds.

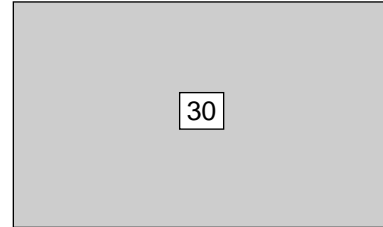

Preparation Display disappears after 30 seconds.

TURNING OFF PROJECTOR

- 1** Press POWER ON-OFF button on Top Control or on Remote Control Unit, and a message "Power off?" appears on a screen.
- 2** Press POWER ON-OFF button again to turn off projector. LAMP Indicator lights bright and READY Indicator turns off. After projector is turned off, Cooling Fans operate (for 90 seconds). During this "Cooling Down" period, the projector cannot be turned on.
- 3** When projector has cooled down, READY Indicator lights GREEN again and you can turn projector on. After cooling down completely, disconnect AC Power Cord.

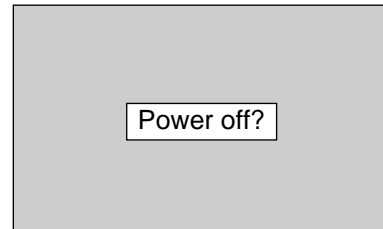

Message disappears after 4 seconds.



TO MAINTAIN THE LIFE OF LAMP, ONCE YOU TURN PROJECTOR ON, WAIT AT LEAST 5 MINUTES BEFORE TURNING IT OFF.

When "Power Management" function is ON, projector detects signal interruption and turns off Projection Lamp automatically. Refer to "Power Management" on page 36.

When WARNING TEMP. Indicator flashes red, projector is automatically turned off. Wait at least 5 minutes before turning on projector again.

When WARNING TEMP. Indicator continues to flash, follow procedures below:

1. Press POWER ON-OFF button to turn a projector off and disconnect AC Power Cord from an AC outlet.
2. Check Air Filters for dust accumulation.
3. Clean Air Filters. (See "AIR FILTER CARE AND CLEANING" section on page 37.)
4. Turn a projector on again.

If WARNING TEMP. Indicator should still continue to flash, call Boxlight at 1-800-762-5757 or 360-779-7901.

ADJUSTING SCREEN

ZOOM ADJUSTMENT

Move ZOOM LEVER upward to make the image larger. Move ZOOM LEVER downward to make the image smaller.

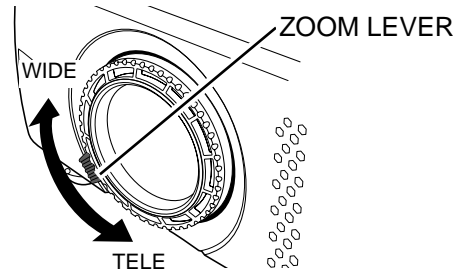

FOCUS ADJUSTMENT

Rotate the FOCUS RING to adjust the projected picture focus.

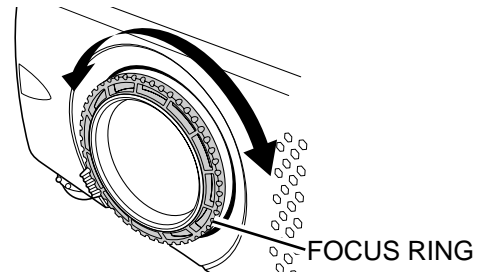

KEYSTONE ADJUSTMENT

If a projected picture has keystone distortion, correct image with KEYSTONE adjustment.

- 1 Press KEYSTONE ▲/▼ button on Remote Control Unit or select Keystone on SETTING menu. (Refer to page 35.) Keystone dialog box appears.
- 2 Correct keystone distortion by pressing KEYSTONE ▲/▼ button or POINT UP/DOWN button(s). Press KEYSTONE ▲ button or POINT UP button to reduce the upper part of image, and press KEYSTONE ▼ button or POINT DOWN button to reduce the lower part.



Reduce the upper width with KEYSTONE ▲ button or POINT UP button.

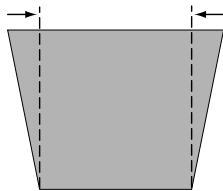

Reduce the lower width with KEYSTONE ▼ button or POINT DOWN button.

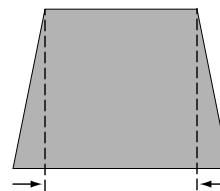

PICTURE FREEZE FUNCTION

Press FREEZE button on Remote Control Unit to freeze the picture on-screen. To cancel FREEZE function, press FREEZE button again or press any other button.

NO SHOW FUNCTION

Press NO SHOW button on Remote Control Unit to black out the image. To restore to normal, press NO SHOW button again or press any other button.

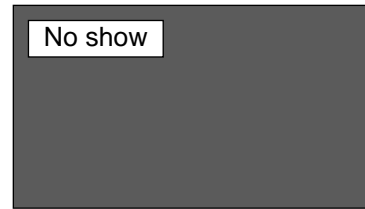

Message disappears after 4 seconds.

P-TIMER FUNCTION

Press P-TIMER button on Remote Control unit. The timer display "00 : 00" appears on the screen and the timer starts to count time (00 : 00 ~ 59 : 59).

To stop P-TIMER display, press P-TIMER button. And then, press P-TIMER button again to cancel P-TIMER function.



SOUND ADJUSTMENT

DIRECT OPERATION

Volume

Press VOLUME (+/-) button(s) on Remote Control Unit or POINT LEFT / RIGHT button on Top Control to adjust volume. Volume dialog box appears on the screen for a few seconds.

VOLUME (+) or POINT RIGHT button to increase volume, and VOLUME (-) or POINT LEFT button for decreasing.

Mute

Press MUTE button on Remote Control Unit to cut off sound. To restore sound to its previous level, press MUTE button again or press Volume (+/-) or POINT LEFT / RIGHT button(s).

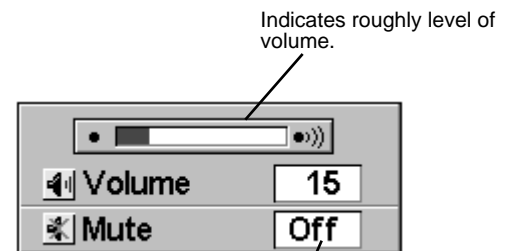

Press MUTE button to set Mute function On or Off.

The display disappears after 4 seconds.

MENU OPERATION

1 Press MENU button and ON-SCREEN MENU will appear. Press POINT LEFT/RIGHT buttons to move a red frame pointer to SOUND Menu icon.

2 Press POINT DOWN button to move a red frame pointer to the item that you want to select, and then press SELECT button.

Volume

To increase volume, press POINT RIGHT button, and press POINT LEFT button for decreasing.

Mute

Press POINT LEFT/RIGHT button(s) to cut off sound. Dialog box display is changed to "On" and sound is cut off. To restore sound to its previous level, press POINT LEFT/RIGHT button(s) again.

SOUND MENU

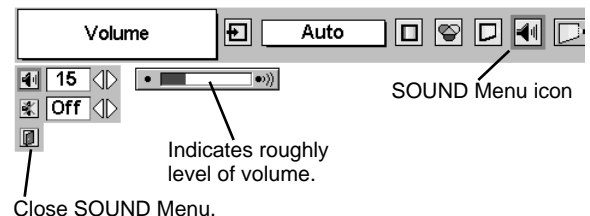

COMPUTER INPUT

SELECTING INPUT SOURCE

DIRECT OPERATION

Choose Computer by pressing INPUT button on Top Control or on Remote Control Unit.

If projector cannot reproduce proper image, select correct input source through MENU OPERATION (see below).



MENU OPERATION

- 1 Press MENU button and ON-SCREEN MENU will appear. Press POINT LEFT/RIGHT button to move a red frame pointer to INPUT Menu icon.
- 2 Press POINT DOWN button to move a red arrow pointer to Computer and then press SELECT button.

INPUT MENU

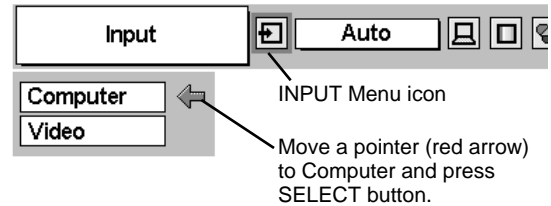

SELECTING COMPUTER SYSTEM

This projector automatically tunes to most different types of computers based on VGA, SVGA, XGA or SXGA (refer to "COMPATIBLE COMPUTER SPECIFICATION" on page 23). When selecting Computer, this projector automatically tunes to incoming signal and projects proper image without any special setting. (Some computers need setting manually.)

Note : Projector may display one of the following messages.

Auto When projector cannot recognize connected signal as PC system provided in this projector, Auto PC Adjustment function operates to adjust projector and the message "Auto" is displayed on SYSTEM Menu icon. (Refer to P24.) When image is not provided properly, manual adjustment is required. (Refer to P25 and 26.)

--- There is no signal input from computer. Make sure the connection of computer and a projector is set correctly. (Refer to TROUBLESHOOTING on page 39.)

PC SYSTEM MENU

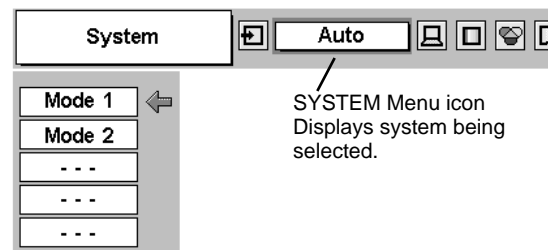

SELECT COMPUTER SYSTEM MANUALLY

This projector automatically selects PC system among those provided in this projector and PC system can be also selected manually.

- 1 Press MENU button and ON-SCREEN MENU will appear. Press POINT LEFT/RIGHT buttons to move a red frame pointer to PC SYSTEM Menu icon.
- 2 Press POINT DOWN button to move a red arrow pointer to the system that you want to set, and then press SELECT button.

PC SYSTEM MENU

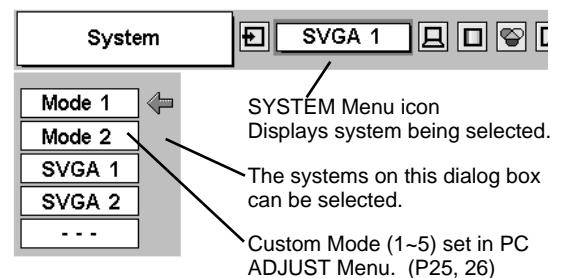

COMPATIBLE COMPUTER SPECIFICATIONS

Basically this projector can accept the signal from all computers with the V, H-Frequency below mentioned and less than 140 MHz of Dot Clock.

ON-SCREEN DISPLAY	RESOLUTION	H-Freq. (kHz)	V-Freq. (Hz)	ON-SCREEN DISPLAY	RESOLUTION	H-Freq. (kHz)	V-Freq. (Hz)
VGA 1	640 x 480	31.47	59.88	XGA 10	1024 x 768	62.04	77.07
VGA 2	720 x 400	31.47	70.09	XGA 11	1024 x 768	61.00	75.70
VGA 3	640 x 400	31.47	70.09	XGA 12	1024 x 768	35.522	86.96 (Interlace)
VGA 4	640 x 480	37.86	74.38	XGA 13	1024 x 768	46.90	58.20
VGA 5	640 x 480	37.86	72.81	XGA 14	1024 x 768	47.00	58.30
VGA 6	640 x 480	37.50	75.00	XGA 15	1024 x 768	58.03	72.00
VGA 7	640 x 480	43.269	85.00	MAC 19	1024 x 768	60.24	75.08
MAC LC13	640 x 480	34.97	66.60	MAC 21	1152 x 870	68.68	75.06
MAC 13	640 x 480	35.00	66.67	SXGA 1	1152 x 864	64.20	70.40
RGB	————	15.625	50 (Interlace)	SXGA 2	1280 x 1024	62.50	58.60
RGB	————	15.734	60 (Interlace)	SXGA 3	1280 x 1024	63.90	60.00
SVGA 1	800 x 600	35.156	56.25	SXGA 4	1280 x 1024	63.34	59.98
SVGA 2	800 x 600	37.88	60.32	SXGA 5	1280 x 1024	63.74	60.01
SVGA 3	800 x 600	46.875	75.00	SXGA 6	1280 x 1024	71.69	67.19
SVGA 4	800 x 600	53.674	85.06	SXGA 7	1280 x 1024	81.13	76.107
SVGA 5	800 x 600	48.08	72.19	SXGA 8	1280 x 1024	63.98	60.02
SVGA 6	800 x 600	37.90	61.03	SXGA 9	1280 x 1024	79.976	75.025
SVGA 7	800 x 600	34.50	55.38	SXGA 10	1280 x 960	60.00	60.00
SVGA 8	800 x 600	38.00	60.51	SXGA 11	1152 x 900	61.20	65.20
SVGA 9	800 x 600	38.60	60.31	SXGA 12	1152 x 900	71.40	75.60
SVGA 10	800 x 600	32.70	51.09	SXGA 13	1280 x 1024	50.00	86.00 (Interlace)
SVGA 11	800 x 600	38.00	60.51	SXGA 14	1280 x 1024	50.00	94.00 (Interlace)
MAC 16	832 x 624	49.72	74.55	SXGA 15	1280 x 1024	63.37	60.01
XGA 1	1024 x 768	48.36	60.00	SXGA 16	1280 x 1024	76.97	72.00
XGA 2	1024 x 768	68.677	84.997	SXGA 17	1152 x 900	61.85	66.00
XGA 3	1024 x 768	60.023	75.03	SXGA 18	1280 x 1024	46.43	86.70 (Interlace)
XGA 4	1024 x 768	56.476	70.07	SXGA 19	1280 x 1024	63.79	60.18
XGA 5	1024 x 768	60.31	74.92	MAC	1280 x 960	75.00	75.08
XGA 6	1024 x 768	48.50	60.02	MAC	1280 x 1024	80.00	75.08
XGA 7	1024 x 768	44.00	54.58	720p (HDTV)	————	45.00	60.00
XGA 8	1024 x 768	63.48	79.35	1035i (HDTV)	————	33.75	60.00 (Interlace)
XGA 9	1024 x 768	36.00	87.17 (Interlace)	1080i (HDTV)	————	33.75	60.00 (Interlace)

NOTE : Specifications are subject to change without notice.

PC ADJUSTMENT

AUTO PC ADJUSTMENT

Auto PC Adjustment function is provided to automatically adjust Fine sync, Total dots and Picture Position to conform to your computer. Auto PC Adjustment function can be operated as follows.



Auto PC Adj.

- 1 Press MENU button and ON-SCREEN MENU will appear. Press POINT LEFT/RIGHT button to move a red frame pointer to PC ADJUST Menu icon.
- 2 Press POINT DOWN button to move a red frame pointer to AUTO PC Adj. icon and then press SELECT button twice. This Auto PC Adjustment can be also executed by pressing AUTO PC ADJ. button on Remote Control Unit.

Store adjustment parameters.

Adjustment parameters from Auto PC Adjustment can be memorized in this projector. Once parameters are memorized, setting can be done just by selecting Mode in PC SYSTEM Menu (P22). Refer to step 3 of MANUAL PC ADJUSTMENT section (P26).

NOTE

- Fine sync, Total dots and Picture Position of some computers can not be fully adjusted with this Auto PC Adjustment function. When the image is not provided properly through this function, manual adjustments are required. (Refer to page 25, 26.)
- Auto PC Adjustment function cannot be operated when "RGB," "720p (HDTV)," "1035i (HDTV)" or "1080i (HDTV)" is selected on PC SYSTEM Menu (P22).

PC ADJUST MENU

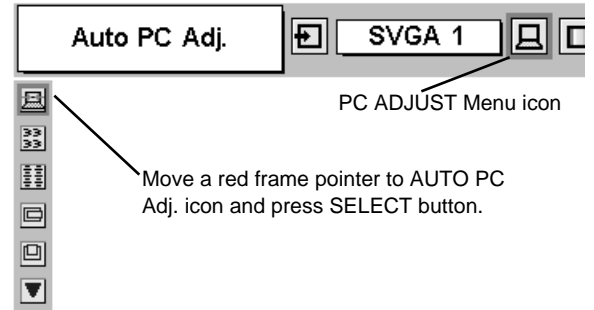

MANUAL PC ADJUSTMENT

This projector can automatically tune to the display signals from most personal computers currently distributed. However, some computers employ special signal formats which are different from the standard ones and may not be tuned by Multi-Scan system of this projector. If this happens, projector cannot reproduce a proper image and the image may be recognized as a flickering picture, a non-synchronized picture, a non-centered picture or a skewed picture.

This projector has a Manual PC Adjustment to enable you to precisely adjust several parameters to match with those special signal formats. This projector has 5 independent memory areas to memorize those parameters manually adjusted. This enables you to recall the setting for a specific computer whenever you use it.

Note : This PC ADJUST Menu cannot be operated when "RGB" is selected on PC SYSTEM Menu (P22).

- 1 Press MENU button and ON-SCREEN MENU will appear. Press POINT LEFT/RIGHT button to move a red frame pointer to PC ADJUST Menu icon.
- 2 Press POINT DOWN button to move a red frame pointer to the item that you want to adjust and then press SELECT button. Adjustment dialog box will appear. Press POINT LEFT/RIGHT button to adjust value.



Fine sync

Adjusts an image as necessary to eliminate flicker from the display. Press POINT LEFT/RIGHT button to adjust value.(From 0 to 31.)



Total dots

The number of total dots in one horizontal period. Press POINT LEFT/RIGHT button(s) and adjust number to match your PC image.



Horizontal

Adjusts horizontal picture position. Press POINT LEFT/RIGHT button(s) to adjust the position.



Vertical

Adjusts vertical picture position. Press POINT LEFT/RIGHT button(s) to adjust the position.



Current mode

Press SELECT button to show the information of computer selected.



Clamp

Adjusts clamp level. When the image has a dark bar(s), try this adjustment.

PC ADJUST MENU

Auto PC Adj. [Left] [Right] [SVGA 1] [PC ADJUST Menu icon]

PC ADJUST Menu icon

Move a red frame icon to the item and press SELECT button.

Selected Mode Shows status (Stored / Free) of the selected Mode.

Fine sync [Mode 1] [Stored]

0 [Left] [Right] Press POINT LEFT/RIGHT button to adjust the value.

1342 [Left] [Right]

296 [Left] [Right]

35 [Left] [Right] Press SELECT button at this icon to adjust "Clamp," "Display area (H/V)" or set "Full screen."

Current mode

Current mode

H-Sync freq.	48.5
V-Sync freq.	60.0

Press SELECT button at Current mode icon to show the information of computer connected.

Display area

Selects area displayed with this projector. Select the resolution at Display area dialog box.

Display area H

Adjustment of horizontal area displayed with this projector. Press POINT LEFT/RIGHT button(s) to decrease/increase value to match the resolution of image.

Display area V

Adjustment of vertical area displayed with this projector. Press POINT LEFT/RIGHT button(s) to decrease/increase value to match the resolution of image.

Full screen

Press POINT LEFT/RIGHT button(s) to switch Full screen function to "On" or "Off." Set "On" to resize the image with 4 x 3 aspect ratio to fit the screen.

NOTE : Fine sync, Total dots, Display area (H/V) and Full screen cannot be adjusted when "1035i (HDTV)" or "1080i (HDTV)" is selected on PC SYSTEM Menu (P22).

3 Store

To store adjustment parameters, move a red frame pointer to Store icon and then press SELECT button. Move a red arrow pointer to any of Mode 1 to 5 that you want to store to and then press SELECT button.

Mode free

To clear adjustment parameters previously set, move a red frame pointer to Mode free icon and then SELECT button. Move a red arrow pointer to the Mode that you want to clear and then press SELECT button.

Other icons operates as follows.

Reset

Reset all adjust parameters on adjustment dialog box to previous figure.

Quit

Closes PC ADJUST MENU.

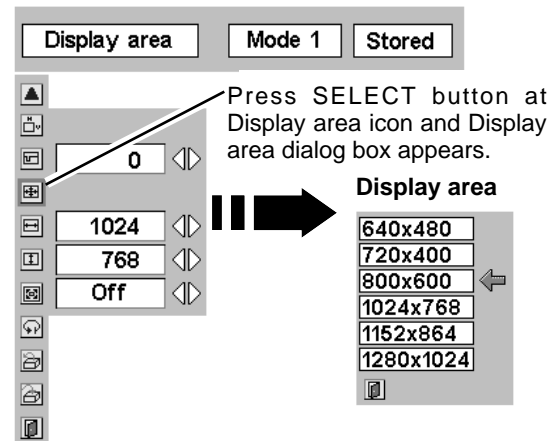

To store adjustment data.

This Mode has parameters being stored.

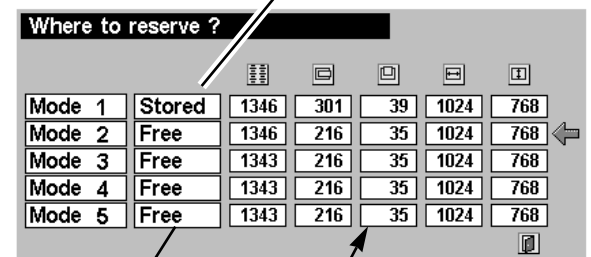

Vacant Mode

Shows values of "Total dots," "Horizontal," "Vertical," "Display area H," and "Display area V."

To clear adjustment data.

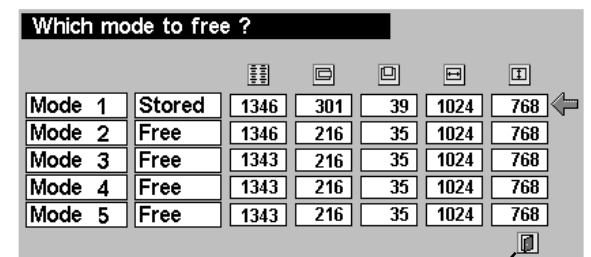

Close this dialog box.

PICTURE IMAGE ADJUSTMENT

IMAGE LEVEL SELECT (DIRECT)

Select image level among Standard, Real, Image 1, Image 2, Image 3 and Image 4 by pressing IMAGE button on Top Control or on Remote Control Unit.

Standard

Normal picture adjustment preset on this projector.

Real

Picture adjustment improved in reproduction of halftones. This adjustment is suitable for providing better image in brighter place.

IMAGE 1~4

User preset picture adjustment in IMAGE ADJUST Menu (P28, 29).

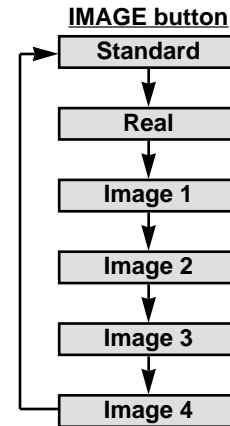

IMAGE LEVEL SELECT (MENU)

1 Press MENU button and ON-SCREEN MENU will appear. Press POINT LEFT/RIGHT button to move a red frame pointer to IMAGE SELECT Menu icon.

2 Press POINT DOWN button to move a red frame pointer to the level that you want to set and then press SELECT button.

Standard

Normal picture adjustment preset on this projector.

Real

Picture adjustment improved in reproduction of halftones. This adjustment is suitable for providing better image in brighter place.

IMAGE 1~4

User preset picture adjustment in IMAGE ADJUST Menu (P28, 29).

IMAGE SELECT MENU

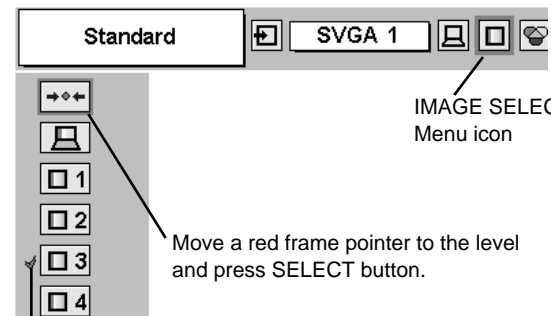

Move a red frame pointer to the level and press SELECT button.

The level being selected.

IMAGE LEVEL ADJUSTMENT

- 1 Press MENU button and ON-SCREEN MENU will appear. Press POINT LEFT/RIGHT buttons to move a red frame pointer to IMAGE ADJUST Menu icon.
- 2 Press POINT DOWN button to move a red frame pointer to the item that you want to adjust. and then press SELECT button. The level of each item is displayed. Adjust each level by pressing POINT LEFT/RIGHT button(s).

Contrast

Press POINT LEFT button to decrease contrast, and POINT RIGHT button to increase contrast. (From 0 to 63.)

Brightness

Press POINT LEFT button to adjust image darker, and POINT RIGHT button to adjust brighter. (From 0 to 63.)

Color

Press POINT LEFT button to lighten color, and POINT RIGHT button to deeper color. (From 0 to 63.)

Tint

Press POINT LEFT button or POINT RIGHT button to obtain proper color. (From 0 to 63.)

White balance (Red)

Press POINT LEFT button to lighten red tone and POINT RIGHT button to deeper tone. (From 0 to 63.)

White balance (Green)

Press POINT LEFT button to lighten green tone and POINT RIGHT button to deeper tone. (From 0 to 63.)

White balance (Blue)

Press POINT LEFT button to lighten blue tone and POINT RIGHT button to deeper tone. (From 0 to 63.)

Sharpness

Press POINT LEFT button to soften the image, and POINT RIGHT button to sharpen the image. (From 0 to 15.)

Gamma

Press either POINT LEFT button or POINT RIGHT button to obtain better balance of contrast. (From 0 to 15.)

IMAGE ADJUST MENU

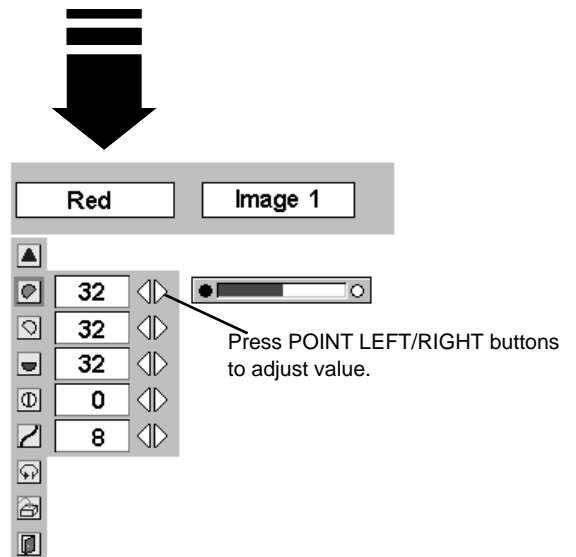
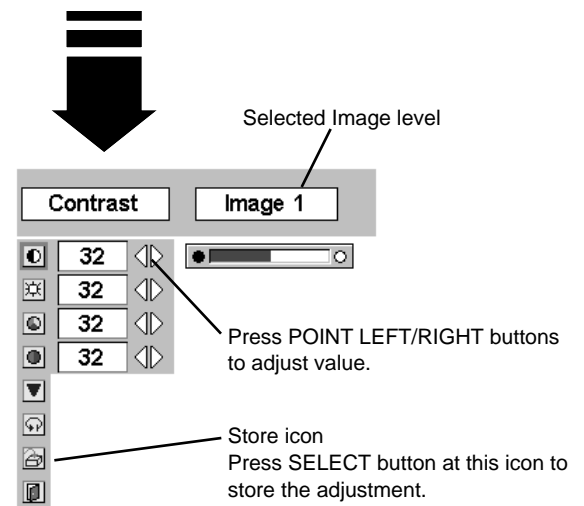
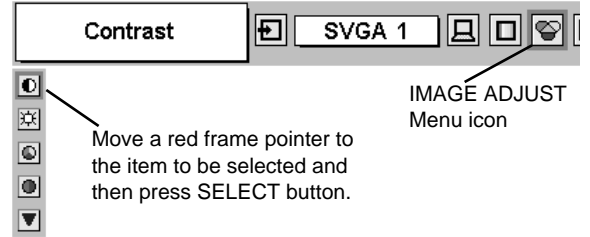

3  **Store**

To store manually preset image, move a red frame pointer to Store icon and press SELECT button. Image Level Menu will appear. Move a red frame pointer to the Image 1 to 4 where you want to set and then press SELECT button.

Other icons operates as follows.

 **Reset**

Reset all adjustment to previous figure.

 **Quit**

Closes IMAGE MENU.

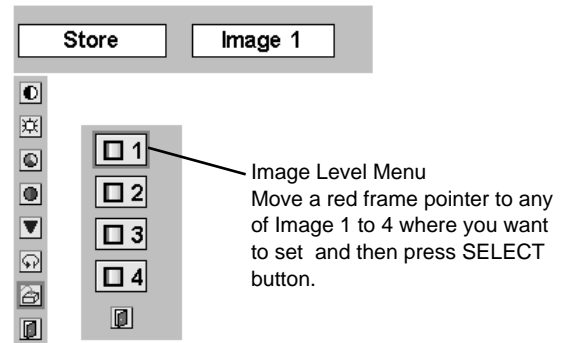

PICTURE SCREEN ADJUSTMENT

This projector has a picture screen resize function, which enables you to display the desirable image size.

1 Press MENU button and ON-SCREEN MENU will appear. Press POINT LEFT/RIGHT button(s) to move a red frame pointer to SCREEN Menu icon.

2 Press POINT DOWN button and move a red frame pointer to the function that you want to select and then press SELECT button.

SCREEN MENU

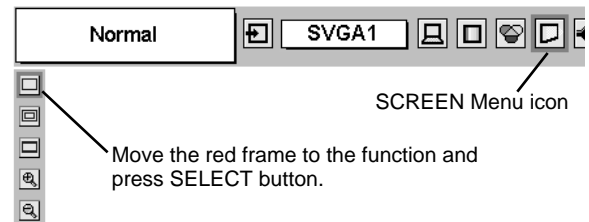

 **Normal**

Provides image to fit screen size.

 **True**

Provides image in its original size. When the original image size is larger than screen size (1024 x 768), this projector enters “Digital zoom +” mode automatically.

 **Wide**

Provides image to fit wide video aspect ratio (16 : 9) by expanding image width uniformly. This function can be used for providing a squeezed video signal at 16 : 9.

 **Digital zoom +**

When Digital zoom + is selected, ON-SCREEN MENU disappears and the message “D. Zoom +” is displayed. Press SELECT button to expand image size. And press POINT UP/DOWN/LEFT/RIGHT button(s) to pan the image. Panning function can work only when the image is larger than screen size.

A projected image can be also expanded by pressing D.ZOOM ▲ button on Remote Control Unit.

 **Digital zoom -**

When Digital zoom - is selected, ON-SCREEN MENU disappears and the message “D. Zoom -” is displayed. Press SELECT button to compress image size.

A projected image can be also compressed by pressing D.ZOOM ▼ button on Remote Control Unit.

To cancel Digital Zoom +/- mode, press any button except D.ZOOM ▲/▼, SELECT, and POINT buttons.

NOTE

- This SCREEN Menu cannot be operated when “1035i (HDTV)” or “1080i (HDTV)” is selected on PC SYSTEM Menu (P22).
- Wide cannot be selected when “720p (HDTV)” is selected on PC SYSTEM Menu (P22).
- True and Digital zoom +/- cannot be selected when “RGB” is selected on PC SYSTEM Menu (P22).
- This projector cannot display any resolution higher than 1280 X 1024. If your computer’s screen resolution is higher than 1280 X 1024, reset the resolution to the lower before connecting projector.
- Digital zoom - cannot be fully operated when the image resolution is higher than XGA (1024 x 768).
- The image data in other than XGA (1024 x 768) is modified to fit the screen size in initial mode.
- Panning function may not operate properly if the computer system prepared on PC ADJUST Menu is used.

SELECTING VIDEO SYSTEM

- 1 Press MENU button and ON-SCREEN MENU will appear. Press POINT LEFT/RIGHT buttons to move a red frame pointer to AV SYSTEM Menu icon.
- 2 Press POINT DOWN button to move a red arrow pointer to the system that you want to select and then press SELECT button.

VIDEO JACK OR S-VIDEO JACK

Auto

Projector automatically detects incoming Video system, and adjusts itself to optimize its performance.
When Video System is PAL-M or PAL-N, select system manually.

PAL / SECAM / NTSC / NTSC4.43 / PAL-M / PAL-N

If projector cannot reproduce proper video image, it is necessary to select a specific broadcast signal format among PAL, SECAM, NTSC, NTSC 4.43, PAL-M, and PAL-N.

AV SYSTEM MENU (VIDEO OR S-VIDEO)

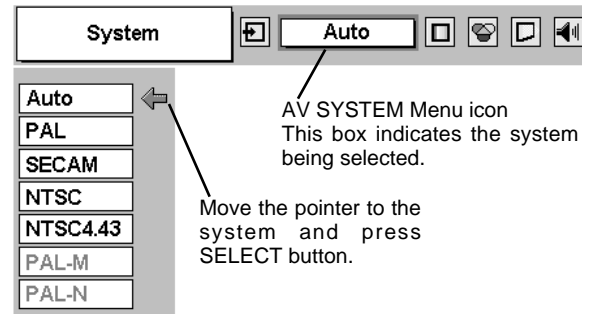

Y, Pb/Cb, Pr/Cr JACKS

Auto

Projector automatically detects incoming Video signal, and adjusts itself to optimize its performance.

COMPONENT VIDEO SIGNAL FORMAT

If projector cannot reproduce proper video image, it is necessary to select a specific component video signal format among 480i, 575i, 480p, 575p, 720p, 1035i and 1080i.

AV SYSTEM MENU (COMPONENT VIDEO)

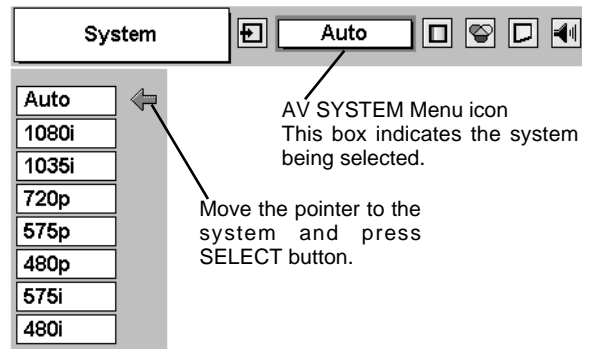

PICTURE IMAGE ADJUSTMENT

IMAGE LEVEL SELECT (DIRECT)

Select image level among Standard, Cinema, Image 1, Image 2, Image 3 and Image 4 by pressing IMAGE button on Top Control or on Remote Control Unit.

Standard

Normal picture adjustment preset on this projector.

Cinema

Picture level adjusted for the picture with fine tone.

IMAGE 1~4

User preset picture adjustment in IMAGE ADJUST Menu (P33,34).



IMAGE LEVEL SELECT (MENU)

1 Press MENU button and ON-SCREEN MENU will appear. Press POINT LEFT/RIGHT button to move a red frame pointer to IMAGE SELECT Menu icon.

2 Press POINT DOWN button to move a red frame pointer to the level that you want to set and then press SELECT button.

Standard

Normal picture adjustment preset on this projector.

Cinema

Picture level adjusted for the picture with fine tone.

1 IMAGE 1~4

User preset picture adjustment in IMAGE ADJUST Menu (P33,34).

IMAGE SELECT MENU

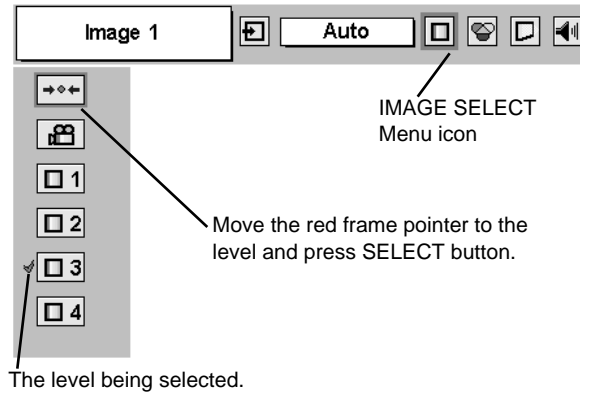

IMAGE LEVEL ADJUSTMENT

- 1 Press MENU button and ON-SCREEN MENU will appear. Press POINT LEFT/RIGHT button(s) to move a red frame pointer to IMAGE ADJUST Menu icon.
- 2 Press POINT DOWN button to move a red frame pointer to the item that you want to adjust and then press SELECT button. The level of each item is displayed. Adjust each level by pressing POINT LEFT/RIGHT button(s).

Contrast

Press POINT LEFT button to decrease contrast, and POINT RIGHT button to increase contrast. (From 0 to 63.)

Brightness

Press POINT LEFT button to adjust image darker, and POINT RIGHT button to adjust brighter. (From 0 to 63.)

Color

Press POINT LEFT button to lighten color, and POINT RIGHT button to deeper color. (From 0 to 63.)

Tint

Press POINT LEFT button or POINT RIGHT button to obtain proper color. (From 0 to 63.)

White balance (Red)

Press POINT LEFT button to lighten red tone and POINT RIGHT button to deeper tone. (From 0 to 63.)

White balance (Green)

Press POINT LEFT button to lighten green tone and POINT RIGHT button to deeper tone. (From 0 to 63.)

White balance (Blue)

Press POINT LEFT button to lighten blue tone and POINT RIGHT button to deeper tone. (From 0 to 63.)

Sharpness

Press POINT LEFT button to soften the image, and POINT RIGHT button to sharpen the image. (From 0 to 15.)

Gamma

Press either POINT LEFT button or POINT RIGHT button to obtain better balance of contrast. (From 0 to 15.)

NOTE : Tint cannot be adjusted when the video system is PAL, SECAM, PAL-M or PAL-N.

IMAGE ADJUST MENU

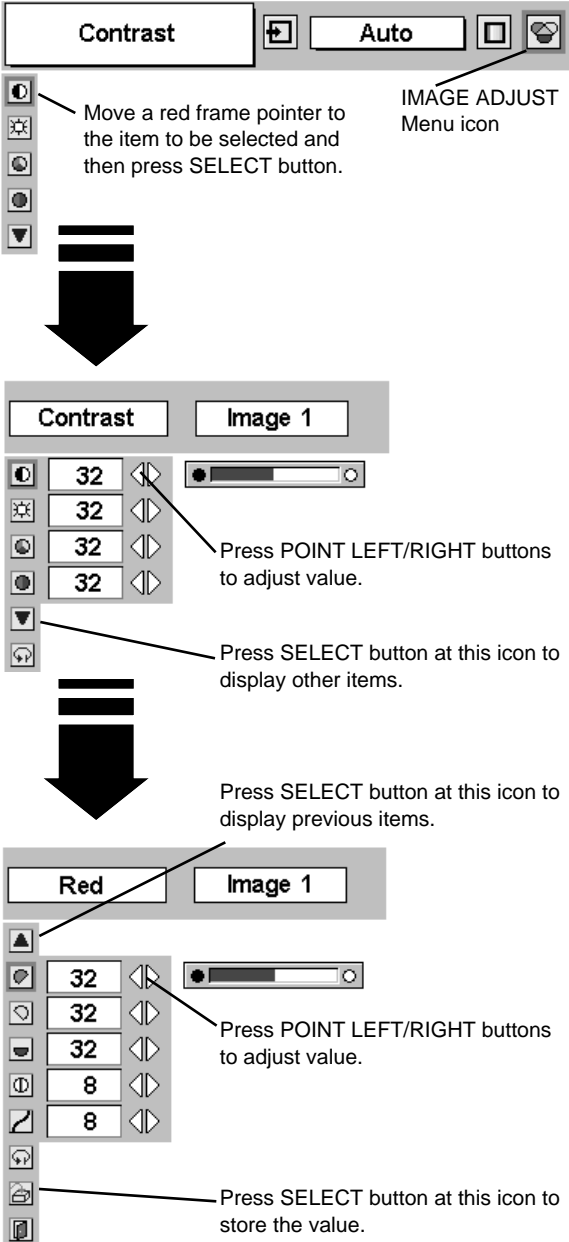

The diagram illustrates the navigation through the IMAGE ADJUST MENU. It shows three sequential screens:

- Screen 1:** Shows the main menu with 'Contrast' selected. The 'IMAGE ADJUST Menu icon' is highlighted. A red frame pointer is shown moving to the 'Contrast' item.
- Screen 2:** Shows the 'Contrast' adjustment screen. The value is '32'. A slider is visible. A red frame pointer is shown moving to the '32' value.
- Screen 3:** Shows the 'Image 1' adjustment screen. The value is '32'. A slider is visible. A red frame pointer is shown moving to the '32' value.

Arrows indicate the flow between screens, and callouts provide instructions on how to navigate and adjust values.

3 Store

To store the adjustment data, move a red frame pointer to Store icon and press SELECT button. Image Level Menu will appear. Move a red frame pointer to the Image Level 1 to 4 and then press SELECT button.

Other icons operates as follows.

Reset

Reset all adjustment to previous figure.

Quit

Closes IMAGE MENU.

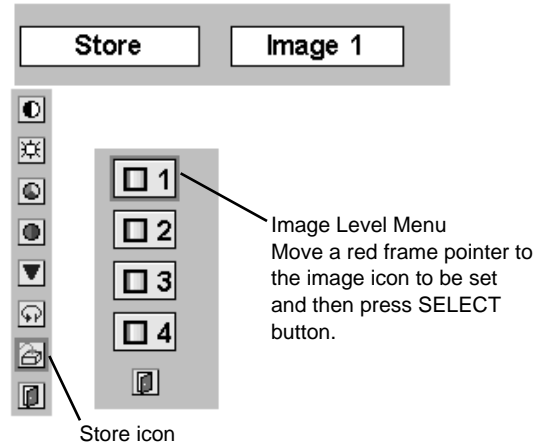

PICTURE SCREEN ADJUSTMENT

This projector has a picture screen resize function, which enables you to display the desirable image size.

- 1 Press MENU button and ON-SCREEN MENU will appear. Press POINT LEFT/RIGHT button(s) to move a red frame pointer to SCREEN Menu icon.
- 2 Press POINT DOWN button and move a red frame pointer to the function that you want to select and then press SELECT button.

Normal

Provides image at a normal video aspect ratio of 4 : 3.

Wide

Provides image at a wide screen ratio of 16 : 9.

SCREEN MENU

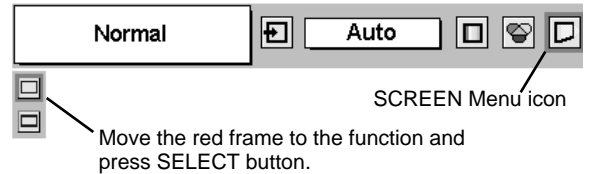

NOTE : SCREEN Menu cannot be operated when "720p," "1035i," or "1080i" is selected on AV SYSTEM Menu (P31).

SETTING MENU

- 1 Press MENU button and ON-SCREEN MENU will appear. Press POINT LEFT/RIGHT button(s) to move a red-frame pointer to SETTING icon.
- 2 Press POINT DOWN button to move a red-frame pointer to the item that you want to set and then press SELECT button. Setting dialog box appears.

Language

Language used in ON-SCREEN MENU is selectable from among English, German, French, Italian, Spanish, Portuguese, Dutch, Swedish, Chinese, Korean and Japanese.

Keystone

When the image is distorted vertically, select Keystone. ON-SCREEN MENU disappears and Keystone dialog box is displayed. Correct keystone distortion by pressing POINT UP/DOWN button(s). Refer to KEYSTONE ADJUSTMENT on page 20.

Blue back

When this function is "On," this projector will produce a blue image instead of the video noise on the screen when any input source is unplugged or turned off.

Display

This function decides whether to display On-Screen Displays.

- On ... shows all the On-Screen Displays.
- Off ... sets On-Screen Displays disappeared except;
 - ON-SCREEN MENU
 - "Power off?" message (P19)
 - P-TIMER
 - "No signal" message (P36)

Logo

When this function is "On," projector displays our logo when starting up.

Ceiling

When this function is "On," picture is top / bottom and left / right reversed. This function is used to project the image from a ceiling mounted projector.

Rear

When this function is "On," picture is left / right reversed. This function is used to project the image to a rear projection screen.

SETTING MENU

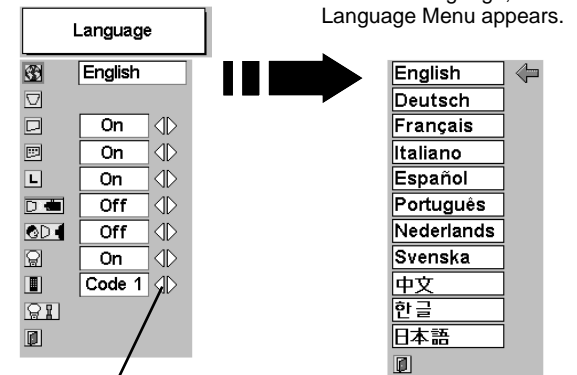
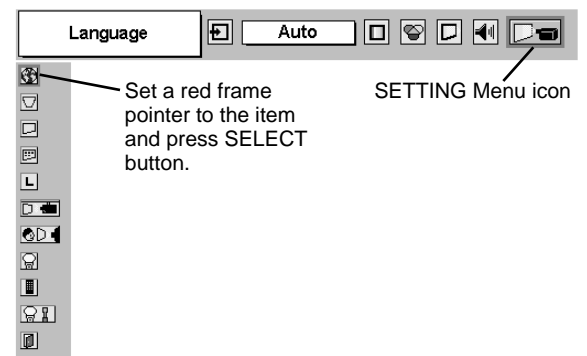

Move a pointer to the item and then press POINT LEFT/RIGHT button(s).

Ceiling function

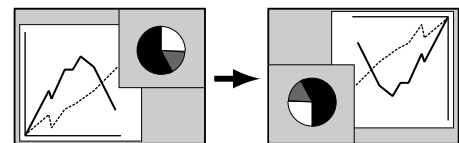

Rear function

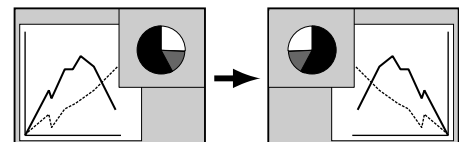



Power management

This function turns Projection Lamp off when this projector detects signal interruption and is not used for a certain period in order to reduce power consumption and maintain the Lamp-life. (This projector is shipped with this function ON.)

Power Management function operates to turn Projection Lamp off when the input signal is interrupted and any button is not pressed over 5 minutes. This function operates as follows;

1. When any input signal is interrupted, "No signal" and the counting down display appears (for 5 minutes).
2. When Projection Lamp turned off, READY Indicator turns off. Cooling Fans operate and Projection Lamp is turned off for 90 seconds. (During this "Cooling Down" period, projector cannot be turned on.)
3. When Projection Lamp has cooled down, READY Indicator flashes and Projection Lamp can be turned on again (Power Management mode).

In this Power Management mode, Projection Lamp is automatically turned on when the input signal connected or projector is operated with any button on Top Control or on Remote Control Unit again.

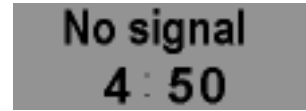

Time left until Lamp off.



Remote control

This projector has two different remote control codes; the factory-set normal code (Code 1) and the secondary code (Code 2). This switching function prevents remote control operation mixture (jam) when operating several projectors or video equipment together. When operating projector in "Code 2," both projector and Remote Control Unit must be switched to "Code 2."

To change the code of Projector;

Set Remote control in the SETTING MENU to "Code 2."

To change the code of the Remote Control Unit;

Press both MENU and IMAGE buttons on Remote Control Unit together for over 10 seconds.

After changing the code, make sure Remote Control operates properly.

To return to the normal code (Code 1), operate both projector and Remote Control in the ways above again.

NOTE : When battery of Remote Control Unit is replaced, the remote control code automatically returns to the normal code (Code 1).

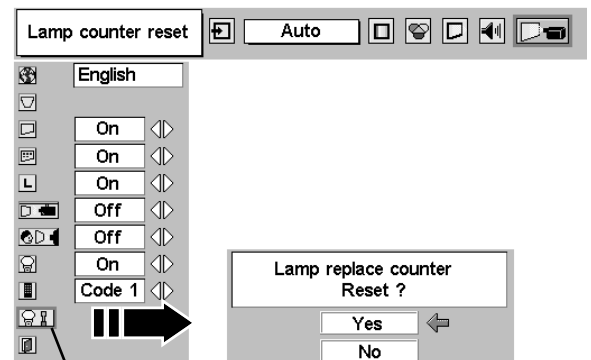

Move the pointer to Lamp counter reset and then press SELECT button. The message "Lamp replace counter reset?" is displayed.



Lamp counter reset

This function is used to reset Lamp Replace Counter. When replacing Projection Lamp, reset Lamp Replace Counter by using this function. Refer to page 38 for operation.

MAINTENANCE

WARNING TEMP. INDICATOR

WARNING TEMP. Indicator flashes red when an internal temperature of a projector exceeds the normal temperature. This Indicator stops flashing when the temperature of a projector returns to normal.

When WARNING TEMP. Indicator continues to flash, check the items listed below.

- 1 Ventilation Slots of the projector may be blocked. In such an event, reposition the projector so that Ventilation Slots are not obstructed.
- 2 Air Filters may be clogged with dust particles. Clean Air Filters by following the section AIR FILTER CARE AND CLEANING below.
- 3 If WARNING TEMP. Indicator remains on after performing the above checks, Cooling Fans or the Internal Circuits may be malfunctioning. In that case, call Boxlight.

AIR FILTER CARE AND CLEANING

Removable Air Filters prevent dust from accumulating on the surface of Projection Lens and Projection Mirror. Should Air Filters become clogged with dust particles, it will reduce Cooling Fans' effectiveness and may result in internal heat build up and adversely affect the life of the projector. Clean Air Filters following the steps below:

- 1 Turn off the projector, and disconnect AC power cord from the AC outlet.
- 2 Turn the projector upside down and remove two Air Filters (Large and Small) by pulling the latches upward.
- 3 Clean Air Filters with a brush or wash out dust and particles.
- 4 Replace each Air Filter properly. Make sure that Air Filters are fully inserted.



CAUTION

Do not operate the projector with Air Filter removed. Dust may accumulate on LCD Panel and Projection Mirror degrading picture quality.

Do not put small parts into Air Intake Vents. It may result in malfunction of the projector.

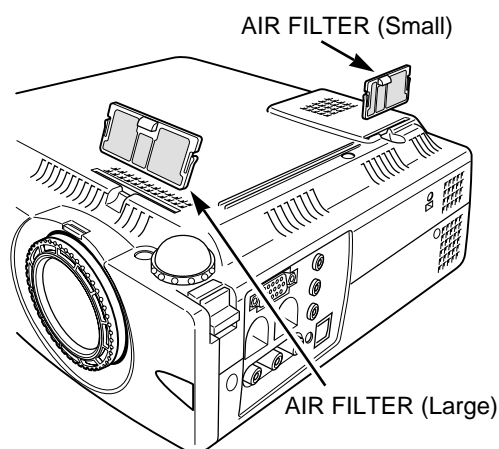

RECOMMENDATION

We recommend avoiding dusty/smoky environments when operating a projector. Usage in these environments may cause poor image quality.

When using under dusty or smoky conditions, dust may accumulate on a lens, liquid crystal panels, or optical elements inside the projector. This condition may degrade the quality of a projected image.

When the above symptoms are noticed, contact Boxlight at 1-800-762-5757 or 360-779-7901 for cleaning.

CLEANING PROJECTION LENS

Follow these steps to clean Projection Lens:

- 1 Apply a non-abrasive camera lens cleaner to a soft, dry cleaning cloth. Avoid using an excessive amount of cleaner. Abrasive cleaners, solvents or other harsh chemicals might scratch a surface.
- 2 Lightly wipe a cleaning cloth over Projection Lens.
- 3 When the projector is not in use, replace Lens Cover.

LAMP REPLACEMENT

When the life of Projection Lamp of this projector draws to an end, LAMP REPLACEMENT indicator lights yellow. When a projected image becomes dark or the color of an image becomes unnatural, replacement of Projection Lamp is required.



CAUTION

For continued safety, replace with a lamp assembly of the same type. Allow a projector to cool for at least 45 minutes before you open Lamp Cover. The inside of a projector can become very hot.



CAUTION

Do not drop a lamp assembly or touch a glass bulb! The glass can shatter and may cause injury.



Follow these steps to replace the lamp assembly.

- 1** Turn off the projector and disconnect AC plug. Allow the projector to cool for at least 45 minutes.
- 2** Remove a screw with a screwdriver to remove Lamp Cover.
- 3** Remove 2 screws with a screwdriver and pull out Lamp Assembly by grasping Handle.
- 4** Replace Lamp Assembly with a new one and tighten 2 screws back. Make sure that Lamp Assembly is set properly. Replace Lamp Cover and tighten a screw.
- 5** Connect AC Power Cord to the projector and turn it on.
- 6** Reset Lamp Replace Counter (refer to the section "Lamp Replace Counter" below).

NOTE : Do not reset Lamp Replace Counter when Projection Lamp is not replaced.

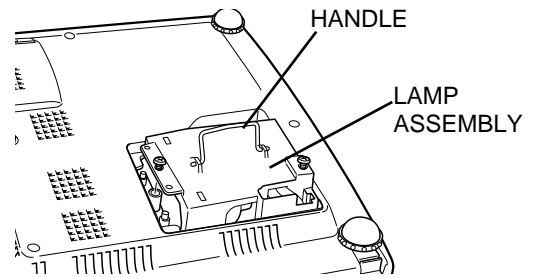
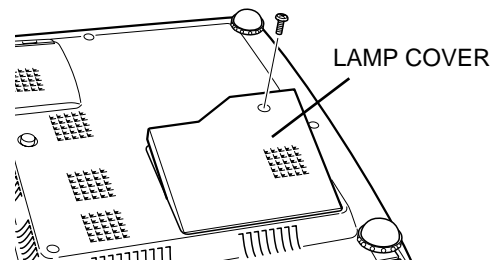

ORDER REPLACEMENT LAMP

Replacement Lamp can be ordered through Boxlight at 1-800-762-5757 or 360-779-7901.

- Model No. of your projector : BOXLIGHT XP-8t
- Replacement Lamp Type No. : POA-LMP36
(Service Parts No. 610 293 8210)

LAMP REPLACE COUNTER

Be sure to reset Lamp Replace Counter when Lamp Assembly is replaced. When Lamp Replace Counter is reset, LAMP REPLACE Indicator stops lighting.

- 1** Turn projector on, press MENU button and ON-SCREEN MENU will appear. Press POINT LEFT/RIGHT button(s) to move a red frame pointer to SETTING Menu icon (refer to page 35, 36).
- 2** Press POINT DOWN button to move a red frame pointer to "Lamp counter reset" and then press SELECT button. The message "Lamp replace counter reset?" is displayed. Move the pointer to [Yes] and then press SELECT button.
- 3** Another confirmation dialog box appears and select [Yes] to reset Lamp Replace Counter.

Do not reset Lamp Replace Counter except after Projection Lamp is replaced.

TROUBLESHOOTING

Before calling your dealer or service center for assistance, check the matters below once again.

1. Make sure you have connected a projector to your computer or video equipment as described in the section "CONNECTING THE PROJECTOR" on pages 11 ~ 13.
2. Check cable connection. Verify that all computer, video and power cord are properly connected.
3. Verify that all power is switched on.
4. If a projector still does not produce an image, re-start your computer.
5. If an image still does not appear, unplug a projector from your computer and check your computer monitor's display. The problem may be with your graphics controller rather than with a projector. (When you reconnect a projector, be sure to turn the computer and monitor off before you power up the projector. Power the equipment back on in order of : Projector and computer.)
6. If the problem still exists, check following chart.

Problem:	Try these Solutions
No power.	<ul style="list-style-type: none"> ● Plug a projector into your AC outlet. ● Make sure READY Indicator lights. ● Wait 90 seconds after a projector is turned OFF when turning the projector back on. <p>NOTE : After pressing Power ON-OFF button to OFF, make sure a projector works as follows:</p> <ol style="list-style-type: none"> 1. LAMP indicator lights bright and READY indicator turns off. 2. After 90 seconds, READY indicator lights green again and a projector may be turned on by pressing Power ON-OFF button. <ul style="list-style-type: none"> ● Check WARNING TEMP. indicator. If the indicator flashes red, the projector cannot be turned on. (See "TURNING ON/OFF PROJECTOR" section on page 19.) ● Check Projection Lamp. (Refer to page 38.)
Image is out of focus.	<ul style="list-style-type: none"> ● Adjust focus of a projector. ● Make sure a projection screen is at least 5.3' (1.6m) from the projector. ● Check Projection Lens to see if it needs cleaning. <p>NOTE : Moving a projector from a cool temperature location to a warm temperature location may result in moisture condensation on Projection Lens. In such an event, leave a projector OFF and wait until condensation disappears.</p>
Picture is Left/Right reversed.	<ul style="list-style-type: none"> ● Check Ceiling / Rear feature. (See "SETTING" section on page 35.)
Picture is Top/Bottom reversed.	<ul style="list-style-type: none"> ● Check Ceiling feature. (See "SETTING" section on page 35.)
Some displays are not seen during the Operation.	<ul style="list-style-type: none"> ● Check Display feature.(See "SETTING" section on page 35.)
No image.	<ul style="list-style-type: none"> ● Check the connection between your computer or video equipment and a projector. ● Check NO SHOW function. (Refer to page 21.) ● When turning a projector on, it takes about 30 seconds to display an image. ● Check the system that you select is corresponding with your computer or video equipment. ● Make sure the temperature is not out of the Operating Temperature (5°C ~ 35°C).
No sound.	<ul style="list-style-type: none"> ● Check audio cable connection from audio input source. ● Adjust the audio source. ● Press VOLUME (+) button. ● Press MUTE button.

Problem:	Try these Solution
Remote Control Unit does not work.	<ul style="list-style-type: none">● Check the battery.● Make sure nothing is between Infrared Remote Receiver and Remote Control Unit.● Make sure you are not too far from a projector when using Remote Control Unit. Maximum operating range is 16.4' (5m).● Make sure the code of Remote Control is set to conform to projector. (See "SETTING" section on page 35, 36.)

WARNING :

High voltages are used to operate this projector. Do not attempt to open the cabinet.

If the problem still persists after following all operating instructions, contact Boxlight for assistance at 1-800-762-5757 or 360-779-7901. Give the model number and explain the difficulty. We will advise you how to obtain service.

Please have the following information available.

- Serial No. of projector.
- Resolution of the computer.
- Refresh rate of computer.



This symbol on the nameplate means the product is Listed by Underwriters Laboratories Inc. It is designed and manufactured to meet rigid U.L. safety standards against risk of fire, casualty and electrical hazards.

TECHNICAL SPECIFICATIONS

Projector Type	Multi-media Projector
Dimensions (W x H x D)	10.12" x 2.98" x 9.02" (257mm x 75.8mm x 229mm) (not including Adjustable Feet and Lens)
Net Weight	6.17lbs (2.8 kg)
LCD Panel System	0.7" TFT Active Matrix type, 3 panels
Panel Resolution	1024 x 768 dots
Number of Pixels	2,359,296 (1024 x 768 x 3 panels)
Color System	PAL, SECAM, NTSC, NTSC4.43, PAL-M and PAL-N
High Definition TV Signal	480i, 480p, 575i, 575p, 720p, 1035i, and 1080i
Scanning Frequency	H-sync. 15 ~ 100 KHz, V-sync. 50 ~ 100 Hz
Projection Image size (Diagonal)	Adjustable from 34" to 200"
Horizontal Resolution	550 TV lines
Projection Lens	F 1.6 ~ 1.78 lens with f 28.7 mm ~ 34.5 mm with manual zoom and focus
Throw Distance	5.3' ~ 26.6' (1.6 m ~ 8.1 m)
Projection Lamp	150 W
Video Input Jacks	RCA Type x 3 (Video/Y, Pb/Cb, Pr/Cr) and Mini DIN 4 pin x 1 (S-Video)
Audio Input Jacks	Mini Jack (stereo) x 1
Computer Input Terminals	(VGA) HDB 15 Terminal x 1
Computer Audio Input Jack	Mini Jack (stereo) x 1
Control Port Connector	Mini DIN 8 pin x 1
USB Connector	USB Series B receptacle x 1
Audio Output Jacks	Mini Jack (stereo) x 1
Internal Audio Amp	1.0 W RMS
Built-in Speakers	1 speaker, ø1.1" (28mm)
Feet Adjustment	0° to 10.6°
Voltage and Power Consumption	AC 100 ~ 120 V (2.8 A Max. Ampere), 50 / 60 Hz (The U.S.A and Canada) AC 200 ~ 240 V (1.4 A Max. Ampere), 50 / 60 Hz (Continental Europe)
Operating Temperature	41 °F ~ 95 °F (5 °C ~ 35 °C)
Storage Temperature	14 °F ~ 140 °F (-10 °C ~ 60 °C)
Remote Control Transmitter	Power Source : Lithium Type (CR2025 / 3.0V) Operating Range : 16.4' (5m) / ±30° Dimensions : 2.1" x 0.28" x 5.3" (54mm x 7mm x 135mm) Net Weight : 1.27oz (36 g) (including battery)
Accessories	Owner's Manual AC Power Cord Wireless Remote Control Transmitter and Battery VGA Cable Carrying Bag Lens Cover

- The specifications are subject to change without notice.

OPTIONAL PARTS

The parts listed below are optionally supplied. When ordering those parts, give name and Type No. of it to the sales dealer.

- Wireless Remote Control Unit Type No. : XP8T-711 ● Control Cable for ADB Port Type No.: POA-MCMAC
- Control Cable for PS/2Port Type No. : POA-MCPS2 ● MAC Adapter Type No.: POA-MACAP
- Control Cable for Serial Port Type No.: POA-MCSRL

CONFIGURATIONS OF THE TERMINALS

COMPUTER INPUT TERMINAL (ANALOG)

Terminal : HDB15-PIN

Connect the display output terminal of the computer to this terminal with the VGA Cable (supplied). When connecting the Macintosh computer, MAC Adapter (not supplied) is required.

Pin Configuration

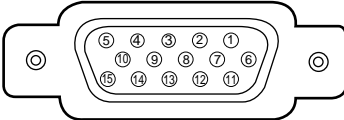

1	Red Input	9	No Connect
2	Green Input	10	Ground (Vert.sync.)
3	Blue Input	11	Sense 0
4	Sense 2	12	Sense 1
5	Ground (Horiz.sync.)	13	Horiz. sync.
6	Ground (Red)	14	Vert. sync.
7	Ground (Green)	15	Reserved
8	Ground (Blue)		

CONTROL PORT CONNECTOR

Terminal : Mini DIN 8-PIN

Connect control port (PS/2, Serial or ADB port) on your computer to this connector with Control Cable (not supplied).

Pin Configuration

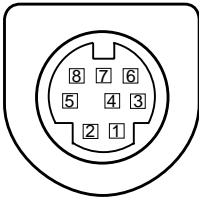

	PS/2	Serial	ADB
1	----	R X D	----
2	CLK	----	ADB
3	DATA	----	----
4	GND	GND	GND
5	----	RTS / CTS	----
6	----	T X D	----
7	GND	GND	----
8	----	GND	GND

USB CONNECTOR (Series B)

Connect USB port terminal on your computer or peripheral equipment to this connector with USB Cable (not supplied).

Pin Configuration

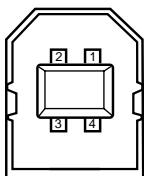

1	Vcc
2	- Data
3	+ Data
4	Ground

LIMITED WARRANTY

BOXLIGHT CORPORATION ("BOXLIGHT") warrants that each BOXLIGHT XP-8t ("the Product") sold hereunder will conform to and function in accordance with the written specifications of BOXLIGHT. Said limited warranty shall apply only to the first person or entity that purchases the Product for personal or business use and not for the purpose of distribution resale. Said warranty shall continue for a period of two (2) years from the date of such purchase. BOXLIGHT does not warrant that the Product will meet the specific requirements of the first person or entity that purchases the Product for personal or business use. Lamp is warranted for 120 days.

BOXLIGHT CORPORATION's liability for the breach of the foregoing limited warranty is limited to the repair or replacement of the Product or refund of the purchase price of the Product, at BOXLIGHT's sole option. To exercise the Purchaser's rights under the foregoing warranty, the Product must be returned at the Purchaser's sole cost and expense, to BOXLIGHT or any authorized service center provided, however, that the Product must be accompanied by a written letter explaining the problem and which includes (i) proof of purchase; (ii) the dealer's name; (iii) the model and serial number of the Product. A return authorization number, issued by the BOXLIGHT customer service department, must also be clearly displayed on the outside of the shipping carton containing the Product.

WARRANTY LIMITATION AND EXCLUSION

BOXLIGHT CORPORATION shall have no further obligation under the foregoing limited warranty if the Product has been damaged due to abuse, misuse, neglect, accident, unusual physical or electrical stress, unauthorized modification, tampering, alterations, or service other than by BOXLIGHT or its authorized agents, causes other than from ordinary use or failure to properly use the Product in the application for which said Product is intended.

DISCLAIMER OR UNSTATED WARRANTIES

The warranty printed above is the only warranty applicable to this purchase.

All other warranties express or implied, including, but not limited to, the implied warranties or merchantability and fitness for a particular purpose are disclaimed. There are no warranties that extend beyond the face of hereof and the foregoing warranty shall not be extended, altered or varied except by written instrument signed by BOXLIGHT CORPORATION.

LIMITATION OR LIABILITY

It is understood and agreed that BOXLIGHT's liability whether in contract, in tort, under any warranty, in negligence or otherwise shall not exceed the return of the amount of the purchase price paid by purchaser and under no circumstances shall BOXLIGHT be liable for special, indirect or consequential damages. The price stated for the Product is a consideration in limiting BOXLIGHT's liability. No action regardless of form, arising out of the agreement to purchase the product, may be brought by purchaser more than one year after the cause of action has accrued.



Boxlight
19332 Powder Hill Place
Poulsbo, WA 98370-7407 USA
www.boxlight.com
USA and Canada 800-762-5757
International 360-779-7901